

GR-1000XL-4

100 US TON MAX. CRANE CAPACITY

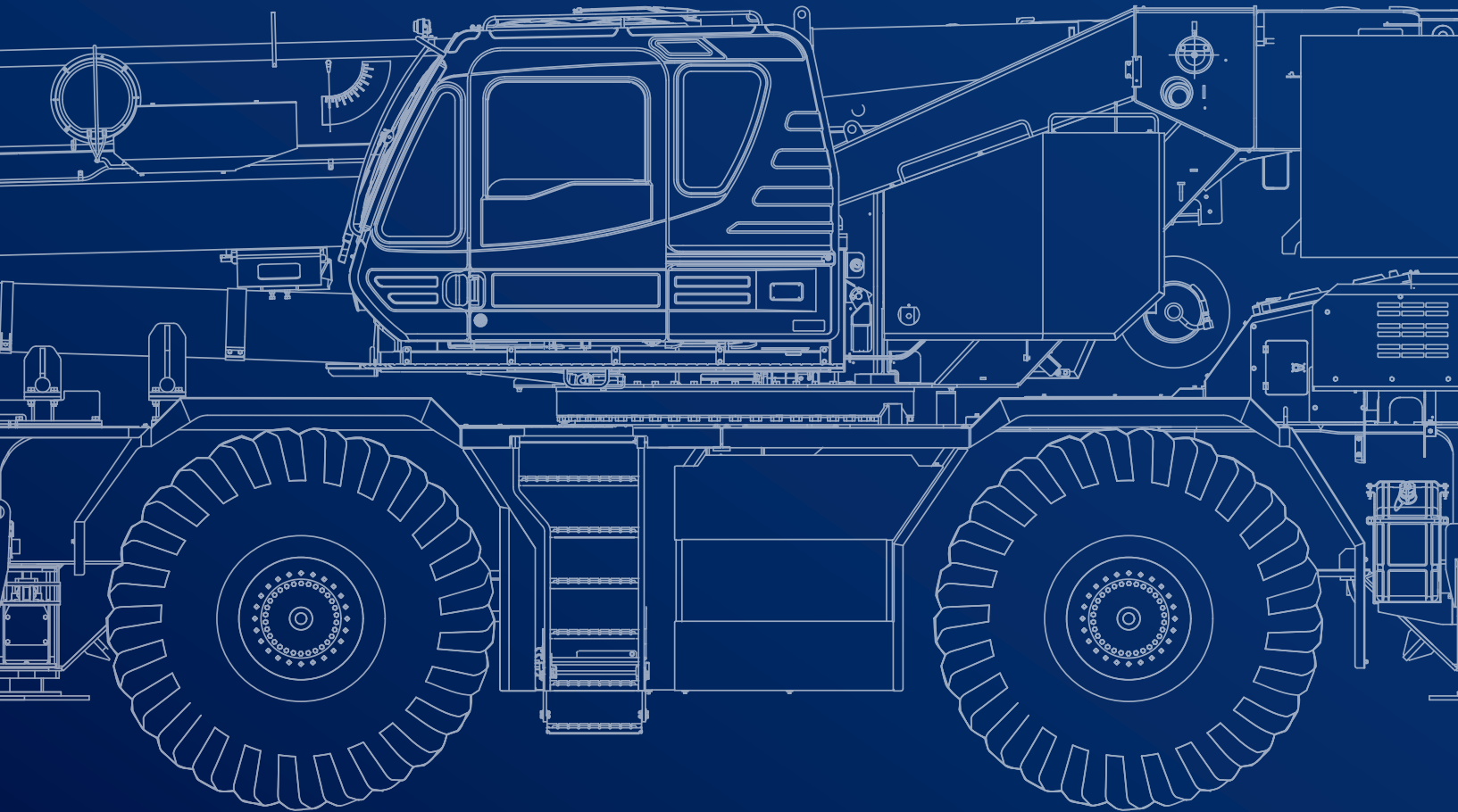



February 2023. Unless otherwise specified, all information in this brochure refers to a standard crane equipment, and it is intended as general information only. No liability is assumed. Errors reserved. Product specifications and prices are subject to changes without notice. The photographs and/or drawings in this brochure are for illustrative purposes only. For correct and safe crane operation, the original operating manual and lifting capacity charts are essential. Failure to follow the corresponding Operator's Manual when using our equipment or failure to otherwise act responsibly may result in property damage, serious injury or death. The sole warranty applicable with respect to our equipment is the standard warranty as per general terms and conditions of sales and service (ask your local Tadano dealer for details), and Tadano makes no other warranty, express or implied. All rights reserved. Any use of the trademarks, logos, brand names and model names used herein is prohibited.

© Tadano Ltd. 2023

Contents

Specifications	5
Vehicle dimensions	6-7
General dimensions	7
Smart counterweight	8
Off-road driving	9
Axle weight distribution chart	10
Speeds and gradeability	10
Steering	10
Operation	11
Main boom	12
Slewing	12
Hoist	12
Line speeds and pulls	13
Drum wire rope capacities	13
Drum dimensions	13
MB: Main boom	14-23
FJ: Folding swing-away jib	24-35
Notes to Lifting Capacity	36
Warning and Operating Instructions for on Rubber Lifting Capacities	37
Notes for Load Moment Indicator (AML-E2)	37
Technical Description	39
Crane specifications	40-41
Carrier specifications	41
Standard equipment	42-43
Optional equipment	43

Key

	Counterweight		Rope diameter
	Lifting capacities on outriggers · 360°		Rope length
	Radius		Hook block
	Main boom		Number of lines
	Main boom length		Number of sheaves in hook block
	Folding swing-away jib		Line pulls available
	Free on wheels		Possible load of hook block
	Tires		Weight of hook block
	Hook block		Distance head sheave axle – hook ground
	Hoist		Max. outrigger load
	Travel speed		Length of stroke (support cylinders)
	Gradeability		Base machine
	Working speeds		Gross vehicle weight
	Rope		Weight on front axle
	Jib		Weight on rear axle
	Boom telescoping		Wire rope layer
	Boom elevation		Total wire rope
	Slewing		Smart Chart: Smart crane control system for main boom and rooster sheave operation enabling higher lifting capacities especially over outriggers. Enables safe use of the full capacity of the crane even in asymmetric outrigger configurations. Visualization of full working area in operator cabin. In-cab lift simulation.
	Max. line pull		

SPECIFICATIONS

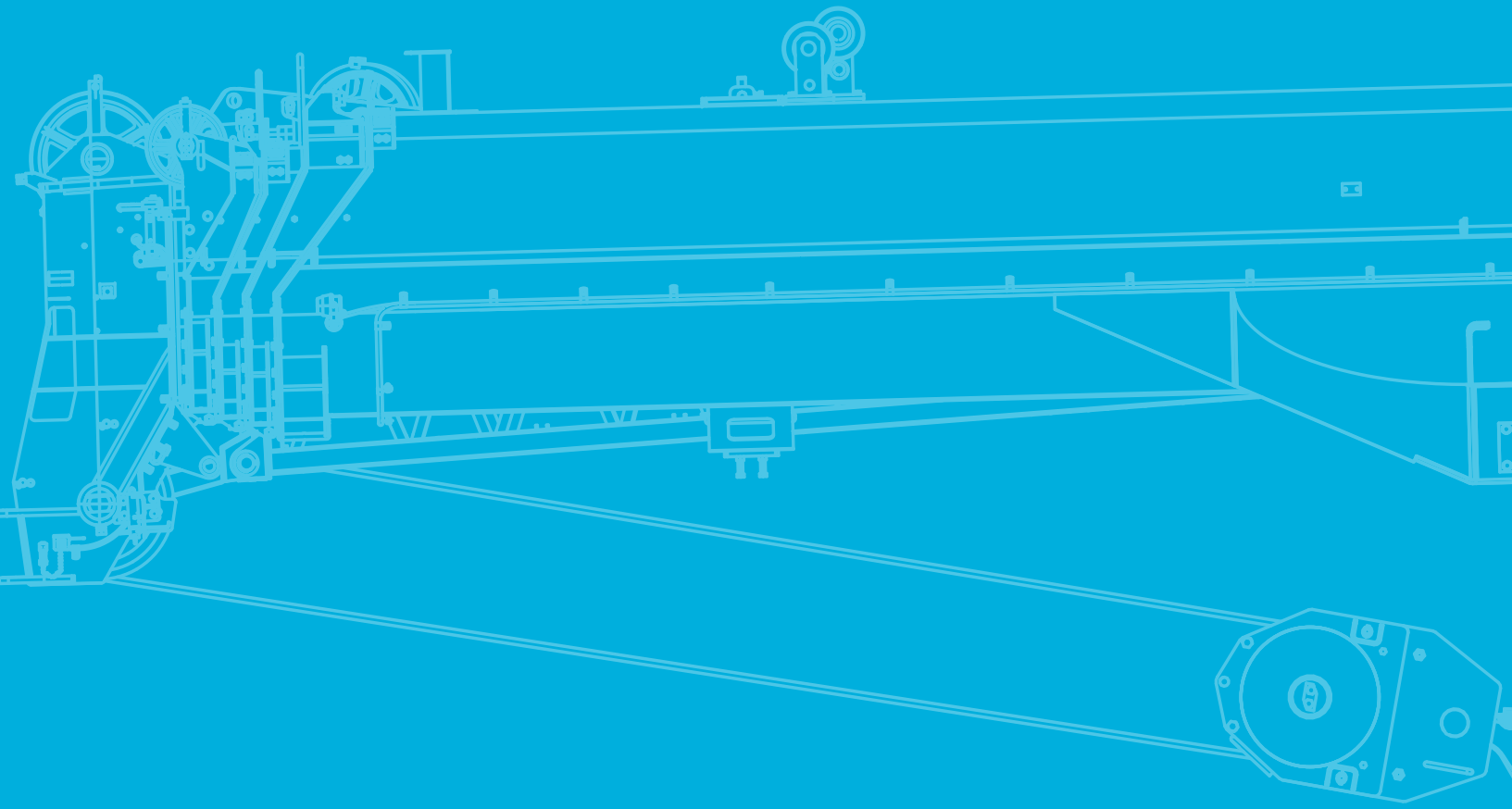

Specifications

Vehicle dimensions

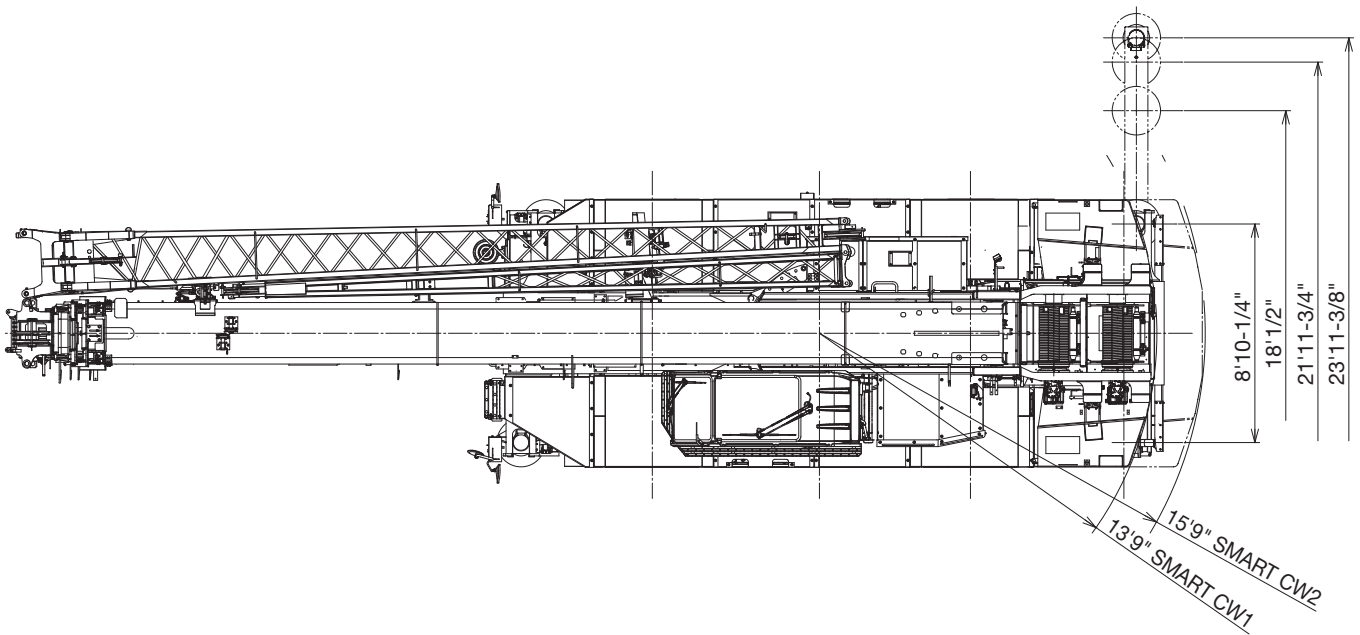
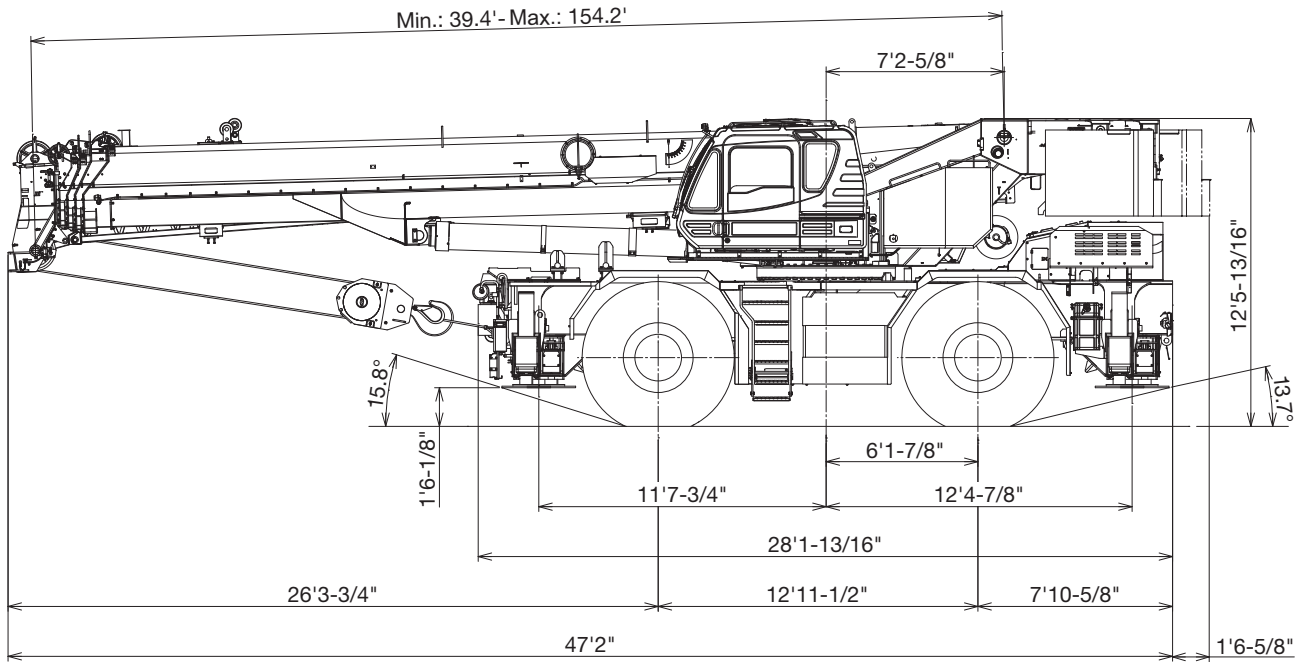

Dimension is with boom angle at -1.5 degree.

Specifications

Vehicle dimensions

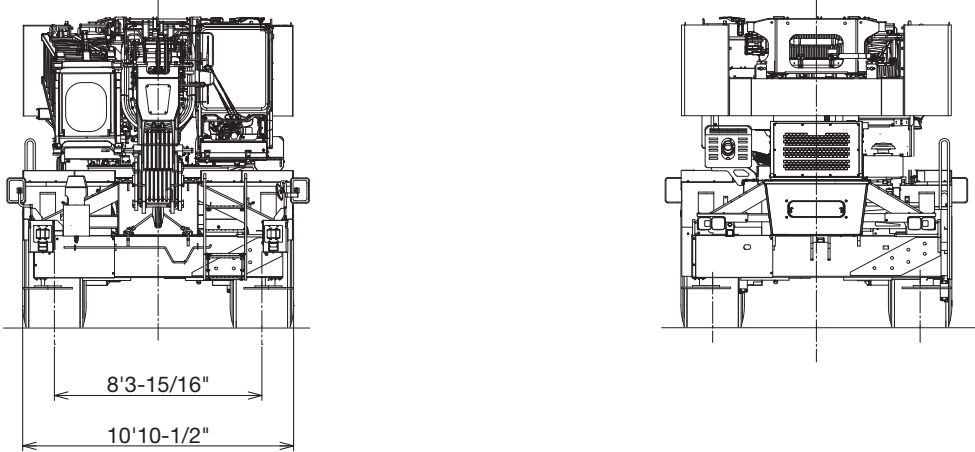

General dimensions

Overall length	approx. 47' 2"
Overall width	approx. 10' 10-1/2"
Overall height	approx. 12' 5-13/16"
4 wheel steer*	22' 4"
2 wheel steer*	35' 9-3/32"

* Turning radius (29.5-25 tires)

Specifications

Smart counterweight

You can increase the capacity by changing the mounting position of the counterweight.

SMART CW 1 status

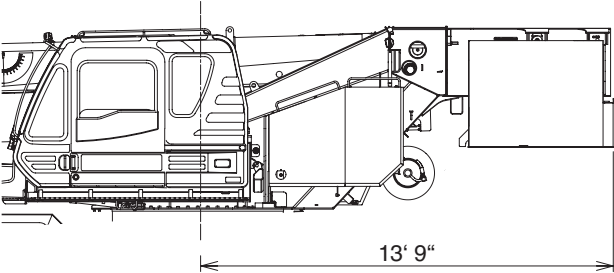

SMART CW 1:
Counterweight is mounted at the front.

SMART CW 2 status

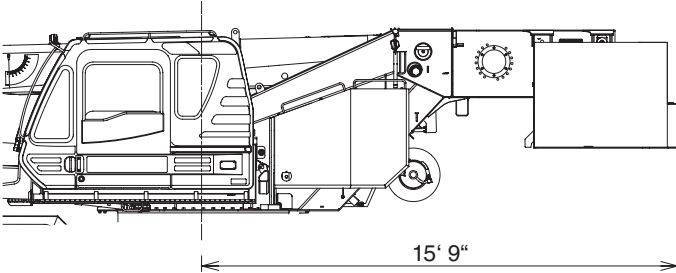





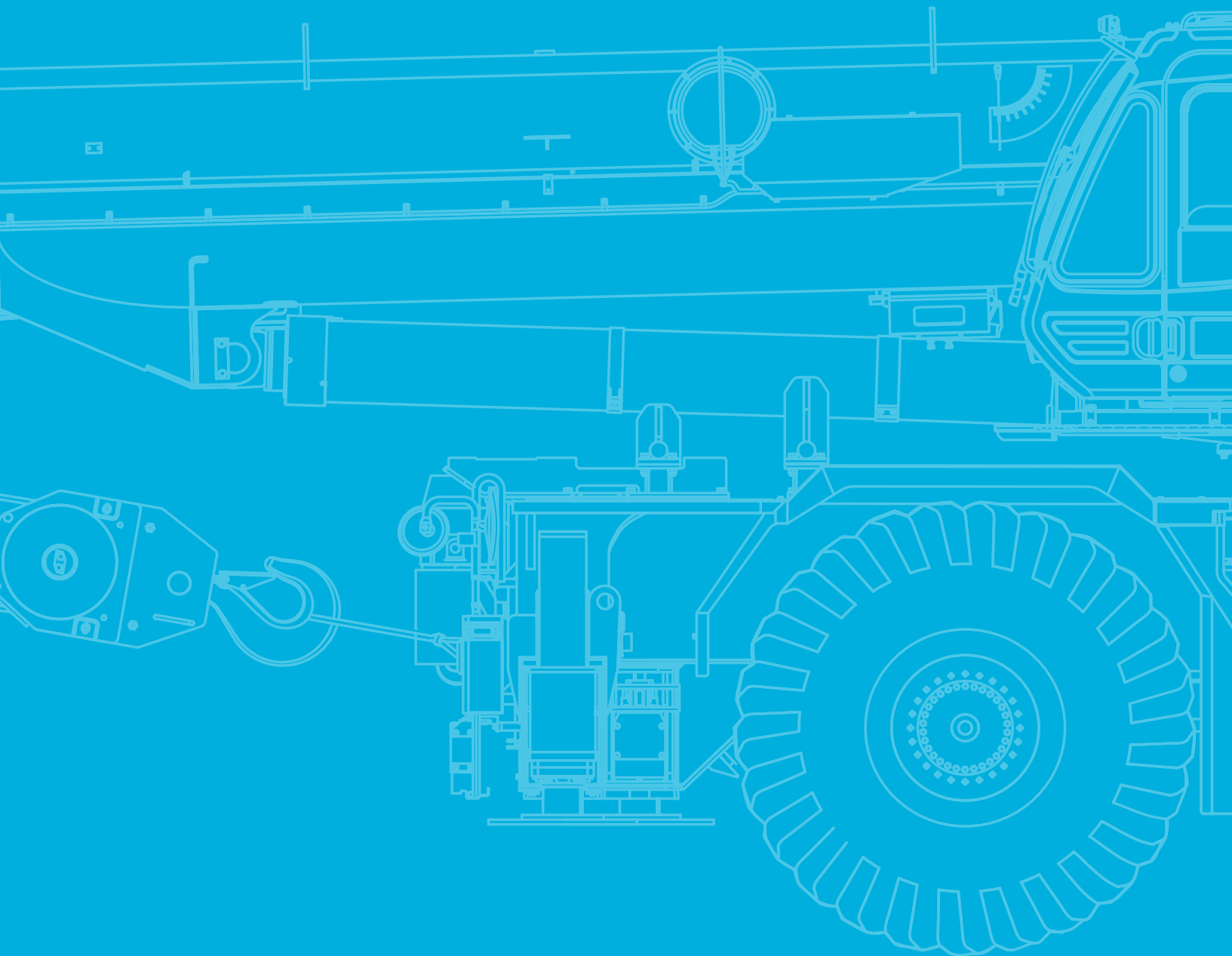



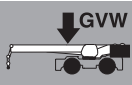
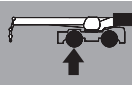

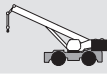
SMART CW 2:
Counterweight is mounted at the rear.



TECHNICAL DATA FOR OFF-ROAD DRIVING

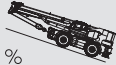

Off-road driving

Axle weight distribution chart			
			
	117,220 lb	58,470 lb	58,750 lb
Remove:			
 7.3 ton	-360 lb	-550 lb	190 lb
 100 ton	-1,900 lb	-3,460 lb	1,590 lb
 Top jib	-740 lb	-990 lb	250 lb
 Base jib	-1,910 lb	-3,760 lb	1,850 lb
 Removable counterweight	-20,100 lb	7,690 lb	-27,760 lb
Add:			
Auxiliary power unit (option)	780 lb	480 lb	300 lb

Speeds and gradeability	
	29.5-25
	93 % at stall 57 % Machine should be operated within the limit of engine crankcase design (30°: Cummins B6.7)
	22 mph

Steering	
	4 wheel steer
	2 wheel steer

TECHNICAL DATA FOR OPERATION

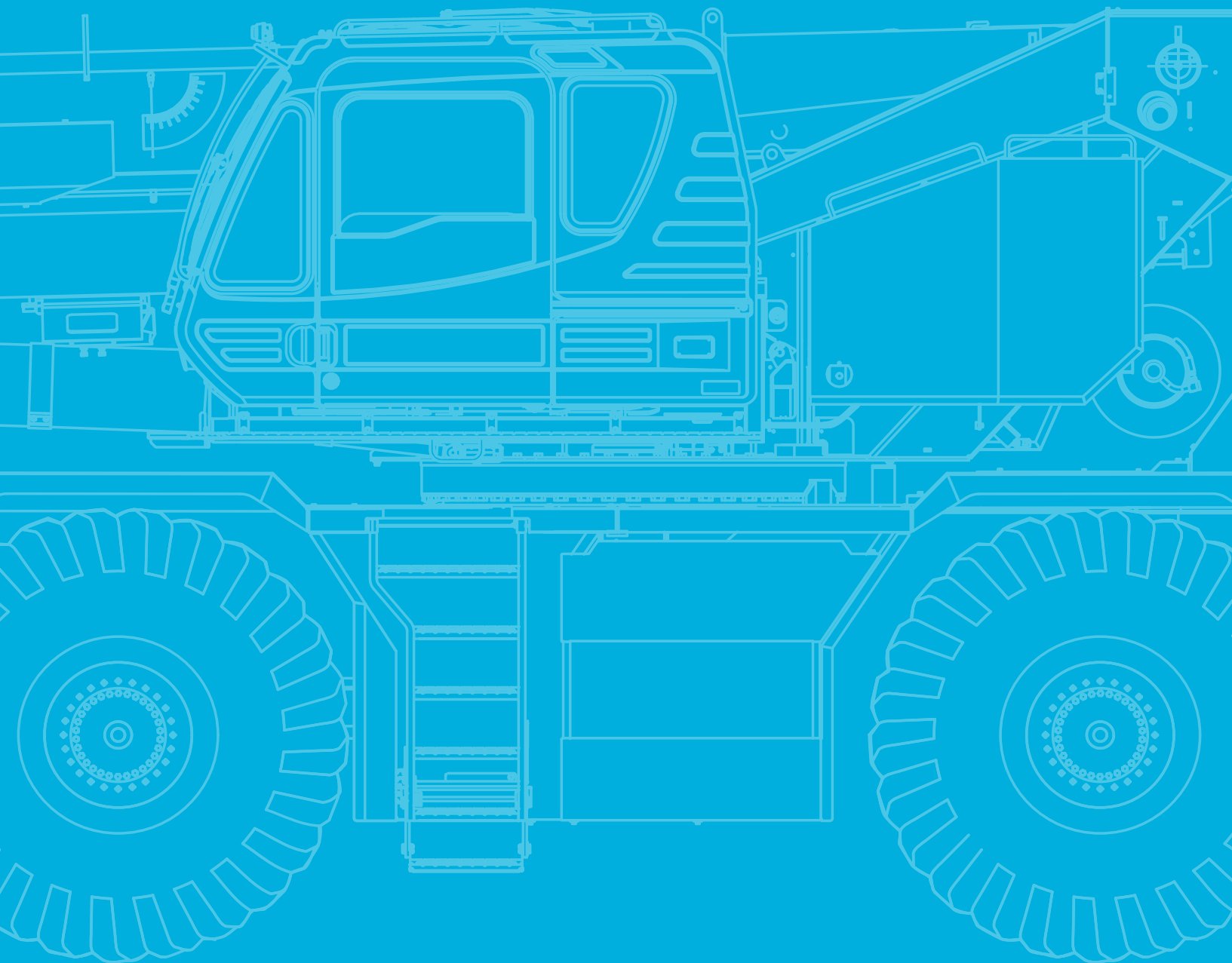

Operation

Main boom



approx. 155 s (39.4 ft - 154.2 ft)







-1.5° - 80.5°
approx. 46 s (20° - 60°)

Slewing



1.5 min⁻¹



Hoist

			
	14,600 lb	3/4"	830'
	14,600 lb	3/4"	456'

Operation

Line speeds and pulls

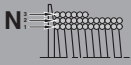
Main or auxiliary hoist - 14'-1/4" drum

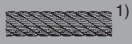
 N	 low		 high	
	low	high	low	high
1	278 ft/min.	387 ft/min.	20,000 lb	14,400 lb
2	302 ft/min.	421 ft/min.	18,100 lb	13,000 lb
3	327 ft/min.	456 ft/min.	16,600 lb	11,900 lb
4	352 ft/min.	491 ft/min.	15,300 lb	10,900 lb
5	377 ft/min.	526 ft/min.	14,100 lb	10,100 lb
6	402 ft/min.	560 ft/min.	13,200 lb	9,400 lb
7 ³⁾	427 ft/min.	595 ft/min.	12,300 lb	8,800 lb

Maximum permissible line pull wire strength 14,600 lb.



1) Line speed based only on hook block, not loaded.

2) Developed by machinery with each layer of wire rope, but not based on rope strength or other limitations in machinery or equipment.

3) Seventh layer of wire rope are not recommended for hoisting operations.

Drum wire rope capacities

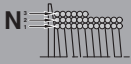
Main and auxiliary drum grooved lagging 3/4" wire rope

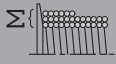
 N		 Σ
1	128.0 ft	128.0 ft
2	139.4 ft	267.4 ft
3	150.9 ft	418.3 ft
4	162.1 ft	580.4 ft
5	173.9 ft	754.3 ft
6	185.4 ft	939.6 ft
7	196.9 ft	1136.5 ft

Drum dimensions



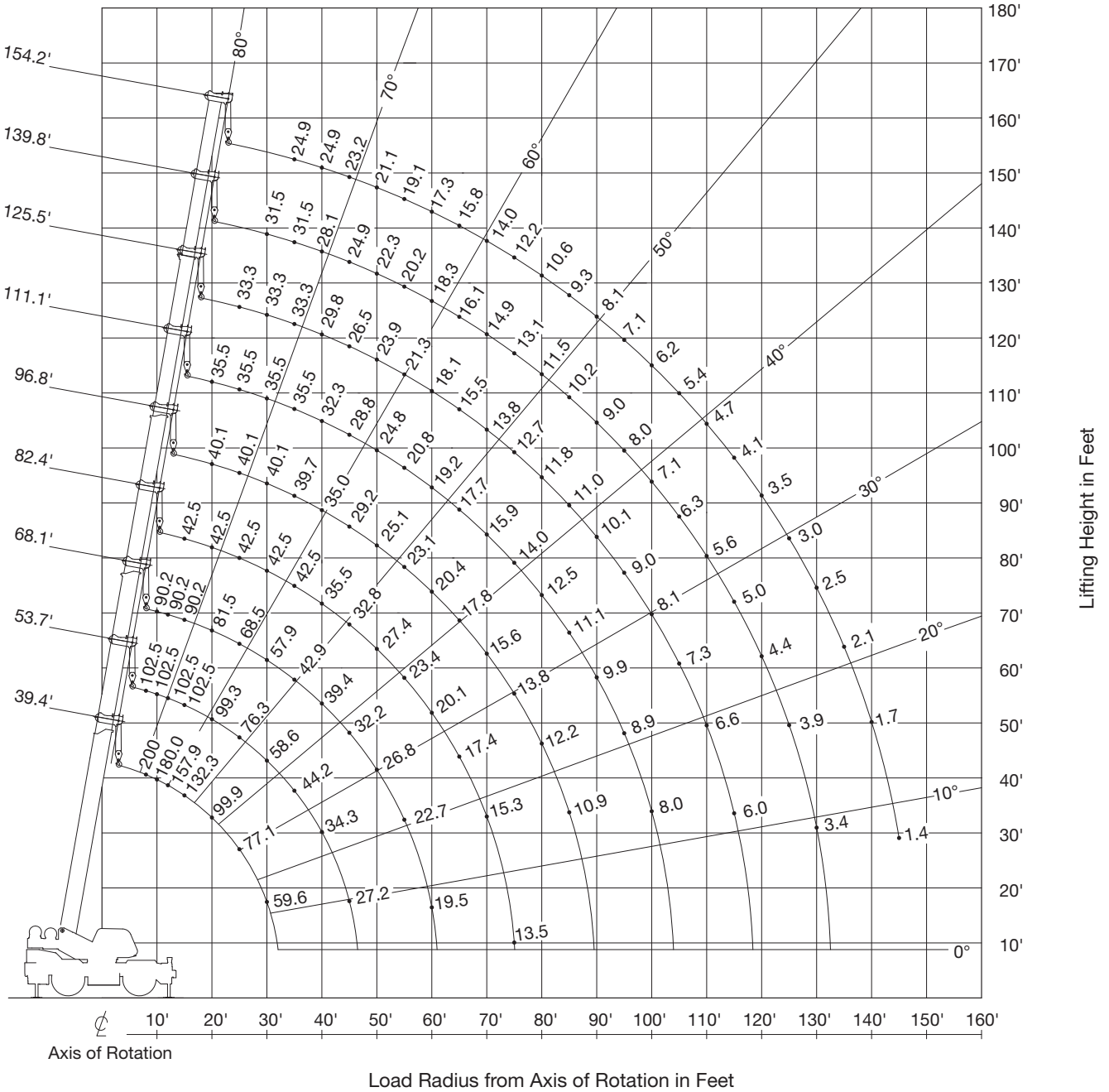





Root diameter	14-1/4"
Length	26-13/16"
Flange diameter	25-7/8"



NOTE: Boom geometry shown is for unloaded condition and machine standing level on firm supporting surface. Boom deflection and subsequent radius and boom angle change must be accounted for when applying load to hook. When boom length is same as telescoping mode 1 and 2, it show large load.



Operation

Fully extended – 360° – SMART CW1

20,100 lb		23' 11-3/8" spread														360°		
		39.4'	53.7'	68.1'	68.1'	82.4'	82.4'	96.8'	96.8'	111.1'	111.1'	125.5'	125.5'	139.8'	139.8'	154.2'		
ft		1,000 lb															ft	
8	200,000	102,500	-	-	-	-	-	-	-	-	-	-	-	-	-	-	8	
10	180,000	102,500	90,200	40,100	-	-	-	-	-	-	-	-	-	-	-	-	10	
12	157,900	102,500	90,200	40,100	-	-	-	-	-	-	-	-	-	-	-	-	12	
15	132,300	102,500	90,200	40,100	42,500	35,500	-	-	-	-	-	-	-	-	-	-	15	
20	99,900	99,300	81,500	40,100	42,500	35,500	40,100	33,300	35,500	32,200	-	-	-	-	-	-	20	
25	77,100	76,300	68,500	40,100	42,500	35,500	40,100	33,300	35,500	32,200	33,300	32,200	-	-	-	-	25	
30	59,600	58,600	57,900	40,100	42,500	35,500	40,100	33,300	35,500	32,200	33,300	28,800	31,500	28,900	-	-	30	
35	-	44,200	42,900	40,100	42,500	35,500	39,700	33,300	35,500	30,800	33,300	25,500	31,500	27,200	24,900	-	35	
40	-	34,300	33,200	39,400	35,200	35,500	35,000	30,500	32,300	27,600	29,800	22,800	28,100	24,500	24,900	-	40	
45	-	27,200	26,300	32,200	28,200	32,800	29,200	27,600	28,800	24,900	26,500	20,700	24,900	22,200	23,200	-	45	
50	-	-	21,200	26,800	23,000	27,400	24,000	25,100	24,800	22,700	23,900	18,800	22,300	20,300	21,100	-	50	
55	-	-	17,300	22,700	19,100	23,400	20,100	23,100	20,800	20,800	21,300	17,300	20,200	18,700	19,100	-	55	
60	-	-	14,300	19,500	15,900	20,100	16,900	20,400	17,600	19,200	18,100	15,900	18,300	17,300	17,300	-	60	
65	-	-	-	13,400	17,400	14,400	17,800	15,000	17,700	15,500	14,800	15,900	16,100	15,800	-	-	65	
70	-	-	-	11,200	15,300	12,200	15,600	12,900	15,900	13,400	13,800	13,700	14,900	14,000	-	-	70	
75	-	-	-	9,500	13,500	10,400	13,800	11,100	14,000	11,600	12,700	11,900	13,100	12,200	-	-	75	
80	-	-	-	-	-	8,900	12,200	9,600	12,500	10,000	11,800	10,400	11,500	10,600	-	-	80	
85	-	-	-	-	-	7,600	10,900	8,300	11,100	8,700	11,000	9,000	10,200	9,300	-	-	85	
90	-	-	-	-	-	-	-	7,100	9,900	7,600	10,100	7,900	9,000	8,100	-	-	90	
95	-	-	-	-	-	-	-	6,100	8,900	6,600	9,000	6,900	8,000	7,100	-	-	95	
100	-	-	-	-	-	-	-	5,200	8,000	5,700	8,100	6,000	7,100	6,200	-	-	100	
105	-	-	-	-	-	-	-	-	-	4,900	7,300	5,200	6,300	5,400	-	-	105	
110	-	-	-	-	-	-	-	-	-	4,200	6,600	4,500	5,600	4,700	-	-	110	
115	-	-	-	-	-	-	-	-	-	3,600	6,000	3,900	5,000	4,100	-	-	115	
120	-	-	-	-	-	-	-	-	-	-	-	3,300	4,400	3,500	-	-	120	
125	-	-	-	-	-	-	-	-	-	-	-	2,800	3,900	3,000	-	-	125	
130	-	-	-	-	-	-	-	-	-	-	-	2,400	3,400	2,500	-	-	130	
135	-	-	-	-	-	-	-	-	-	-	-	-	-	2,100	-	-	135	
140	-	-	-	-	-	-	-	-	-	-	-	-	-	1,700	-	-	140	
145	-	-	-	-	-	-	-	-	-	-	-	-	-	1,400	-	-	145	
 1)	0°	0°	0°	0°	0°	0°	0°	0°	0°	0°	0°	0°	0°	10°	0°	11°		
2)	1, 2	1	1	2	1	2	1	2	1	2	1	2	1	2	1	2	1, 2	2)
	2.	0	50	100	0	100	0	100	0	100	0	100	0	100	50	100		
	3.	0	0	0	33	16	50	33	67	50	83	67	100	83	100	100		
	4.	0	0	0	33	16	50	33	67	50	83	67	100	83	100	100		
	Top	0	0	0	33	16	50	33	67	50	83	67	100	83	100	100		
	39.4	53.7	68.1	68.1	82.4	82.4	96.8	96.8	111.1	111.1	125.5	125.5		139.8			(ft)	
	32.4	46.7	60.9	60.8	75.1	74.9	89.2	88.9	103.5	102.9	117.6	116.9		131.3			(ft)	
 3)	2,4100	13,800	7,300	12,800	7,500	13,600	3,400	6,800	2,200	5,600	1,400	4,500		2,300			(lb)	
1)	1, 2	1	1	2	1	2	1	2	1	2	1	2		2				

- 1) Minimum boom angle (°) for indicated length (no load)
- 2) Telescopic mode
- 3) Loaded boom angle (°)

NOTE:
 The lifting capacity data stored in the LOAD MOMENT INDICATOR (AML-E2) is based on the standard number of parts of line listed in the chart.
 Standard number of parts of line for each boom length should be according to the following table:

	39.4'	39.4' to 68.1'	68.1' to 154.2'	Single top jib
1)	1, 2	1	2	1, 2
	16	8	4	4

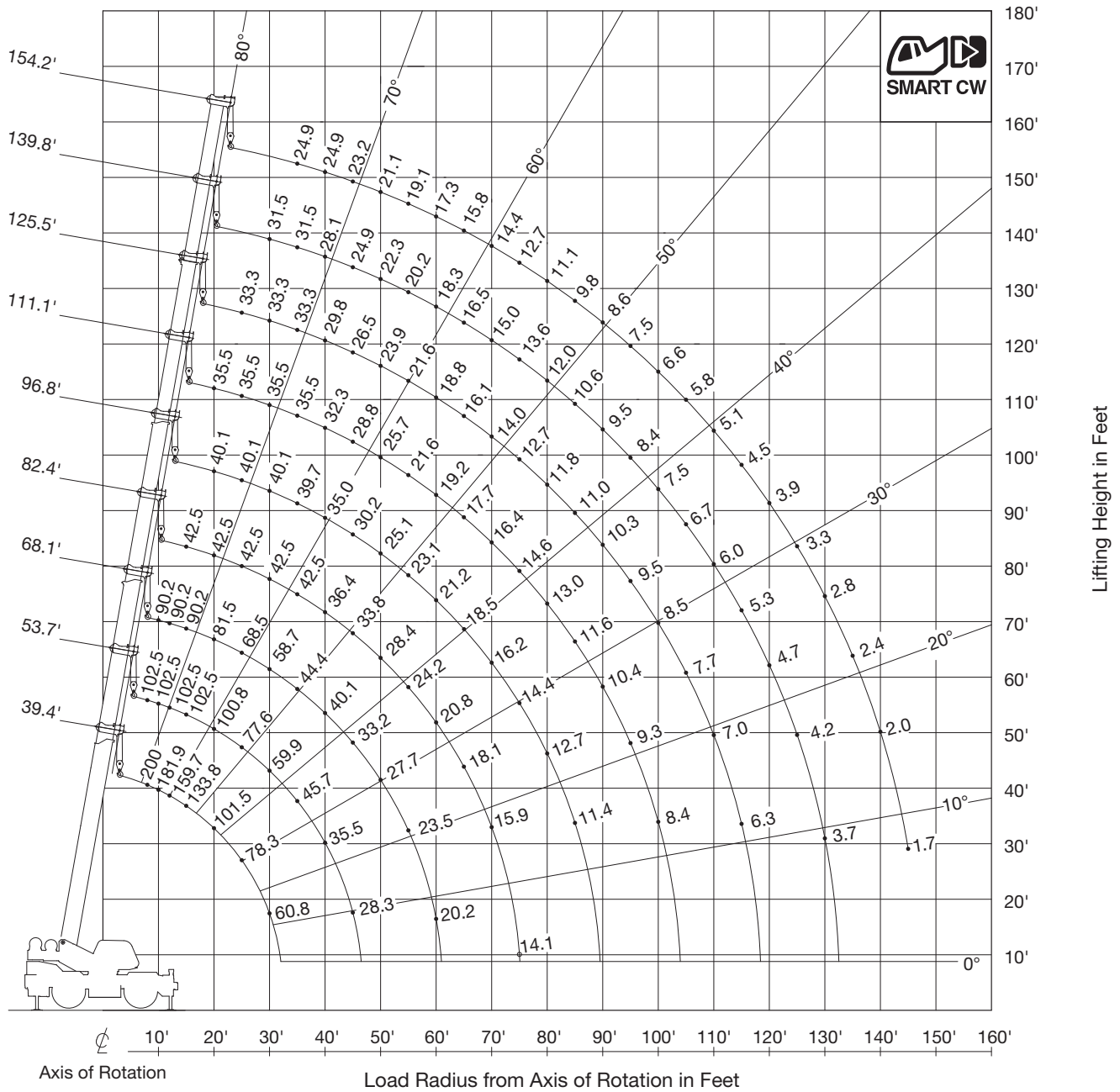

BOOM

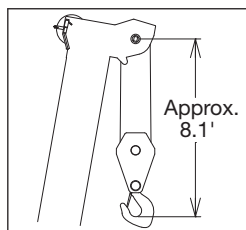

SINGLE TOP

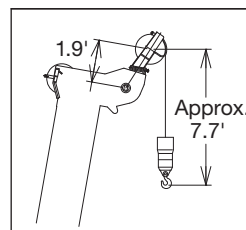

NOTE: Boom geometry shown is for unloaded condition and machine standing level on firm supporting surface. Boom deflection and subsequent radius and boom angle change must be accounted for when applying load to hook. When boom length is same as telescoping mode 1 and 2, it show large load.

Operation

Fully extended – 360° – SMART CW2

20,100 lb		23' 11-3/8" spread												360°			
		39.4'	53.7'	68.1'	68.1'	82.4'	82.4'	96.8'	96.8'	111.1'	111.1'	125.5'	125.5'	139.8'	139.8'	154.2'	
ft	1,000 lb															ft	
8	200,000	102,500	-	-	-	-	-	-	-	-	-	-	-	-	-	-	8
10	181,900	102,500	90,200	40,100	-	-	-	-	-	-	-	-	-	-	-	-	10
12	159,700	102,500	90,200	40,100	-	-	-	-	-	-	-	-	-	-	-	-	12
15	133,800	102,500	90,200	40,100	42,500	35,500	-	-	-	-	-	-	-	-	-	-	15
20	101,500	100,800	81,500	40,100	42,500	35,500	40,100	33,300	35,500	32,200	-	-	-	-	-	-	20
25	78,300	77,600	68,500	40,100	42,500	35,500	40,100	33,300	35,500	32,200	33,300	32,200	-	-	-	-	25
30	60,800	59,900	58,700	40,100	42,500	35,500	40,100	33,300	35,500	32,200	33,300	28,800	31,500	28,900	-	-	30
35	-	45,700	44,400	40,100	42,500	35,500	39,700	33,300	35,500	30,800	33,300	25,500	31,500	27,200	24,900	-	35
40	-	35,500	34,400	40,100	36,400	35,500	35,000	30,500	32,300	27,600	29,800	22,800	28,100	24,500	24,900	-	40
45	-	28,300	27,300	33,200	29,200	33,800	30,200	27,600	28,800	24,900	26,500	20,700	24,900	22,200	23,200	-	45
50	-	-	22,100	27,700	23,900	28,400	24,900	25,100	25,700	22,700	23,900	18,800	22,300	20,300	21,100	-	50
55	-	-	18,100	23,500	19,900	24,200	20,900	23,100	21,600	20,800	21,600	17,300	20,200	18,700	19,100	-	55
60	-	-	15,000	20,200	16,600	20,800	17,600	21,200	18,300	19,200	18,800	15,900	18,300	17,300	17,300	-	60
65	-	-	-	-	14,000	18,100	15,000	18,500	15,700	17,700	16,100	14,800	16,500	16,100	15,800	-	65
70	-	-	-	-	11,800	15,900	12,800	16,200	13,500	16,400	14,000	13,800	14,300	15,000	14,400	-	70
75	-	-	-	-	10,100	14,100	11,000	14,400	11,700	14,600	12,100	12,700	12,500	13,600	12,700	-	75
80	-	-	-	-	-	-	9,400	12,700	10,100	13,000	10,500	11,800	10,900	12,000	11,100	-	80
85	-	-	-	-	-	-	8,100	11,400	8,700	11,600	9,200	11,000	9,500	10,600	9,800	-	85
90	-	-	-	-	-	-	-	-	7,600	10,400	8,000	10,300	8,300	9,500	8,600	-	90
95	-	-	-	-	-	-	-	-	6,500	9,300	7,000	9,500	7,300	8,400	7,500	-	95
100	-	-	-	-	-	-	-	-	5,600	8,400	6,100	8,500	6,400	7,500	6,600	-	100
105	-	-	-	-	-	-	-	-	-	-	5,300	7,700	5,600	6,700	5,800	-	105
110	-	-	-	-	-	-	-	-	-	-	4,500	7,000	4,900	6,000	5,100	-	110
115	-	-	-	-	-	-	-	-	-	-	3,900	6,300	4,200	5,300	4,500	-	115
120	-	-	-	-	-	-	-	-	-	-	-	-	3,600	4,700	3,900	-	120
125	-	-	-	-	-	-	-	-	-	-	-	-	3,100	4,200	3,300	-	125
130	-	-	-	-	-	-	-	-	-	-	-	-	2,700	3,700	2,800	-	130
135	-	-	-	-	-	-	-	-	-	-	-	-	-	-	2,400	-	135
140	-	-	-	-	-	-	-	-	-	-	-	-	-	-	2,000	-	140
145	-	-	-	-	-	-	-	-	-	-	-	-	-	-	1,700	-	145
	1)	0°	0°	0°	0°	0°	0°	0°	0°	0°	0°	0°	0°	10°	0°	11°	
2)		1, 2	1	1	2	1	2	1	2	1	2	1	2	1	2	1, 2	2)
	3.	0	50	100	0	100	0	100	0	100	0	100	0	100	50	100	
	4.	0	0	0	33	16	50	33	67	50	83	67	100	83	100	100	
	Top	0	0	0	33	16	50	33	67	50	83	67	100	83	100	100	
		39.4	53.7	68.1	68.1	82.4	82.4	96.8	96.8	111.1	111.1	125.5	125.5		139.8		(ft)
		32.4	46.7	60.9	60.8	75.1	74.9	89.2	88.9	103.5	102.9	117.6	116.9		131.3		(ft)
	3)	2,4100	13,800	7,300	12,900	7,800	14,100	3,500	6,900	2,200	5,700	1,500	4,600		2,500		(lb)
1)		1, 2	1	1	2	1	2	1	2	1	2	1	2		2		

- 1) Minimum boom angle (°) for indicated length (no load)
- 2) Telescopic mode
- 3) Loaded boom angle (°)

NOTE: The lifting capacity data stored in the LOAD MOMENT INDICATOR (AML-E2) is based on the standard number of parts of line listed in the chart. Standard number of parts of line for each boom length should be according to the following table:



SMART CW2

	39.4'	39.4' to 68.1'	68.1' to 154.2'	Single top jib
1)	1, 2	1 2	1, 2	1, 2
	16	8 4	4	1

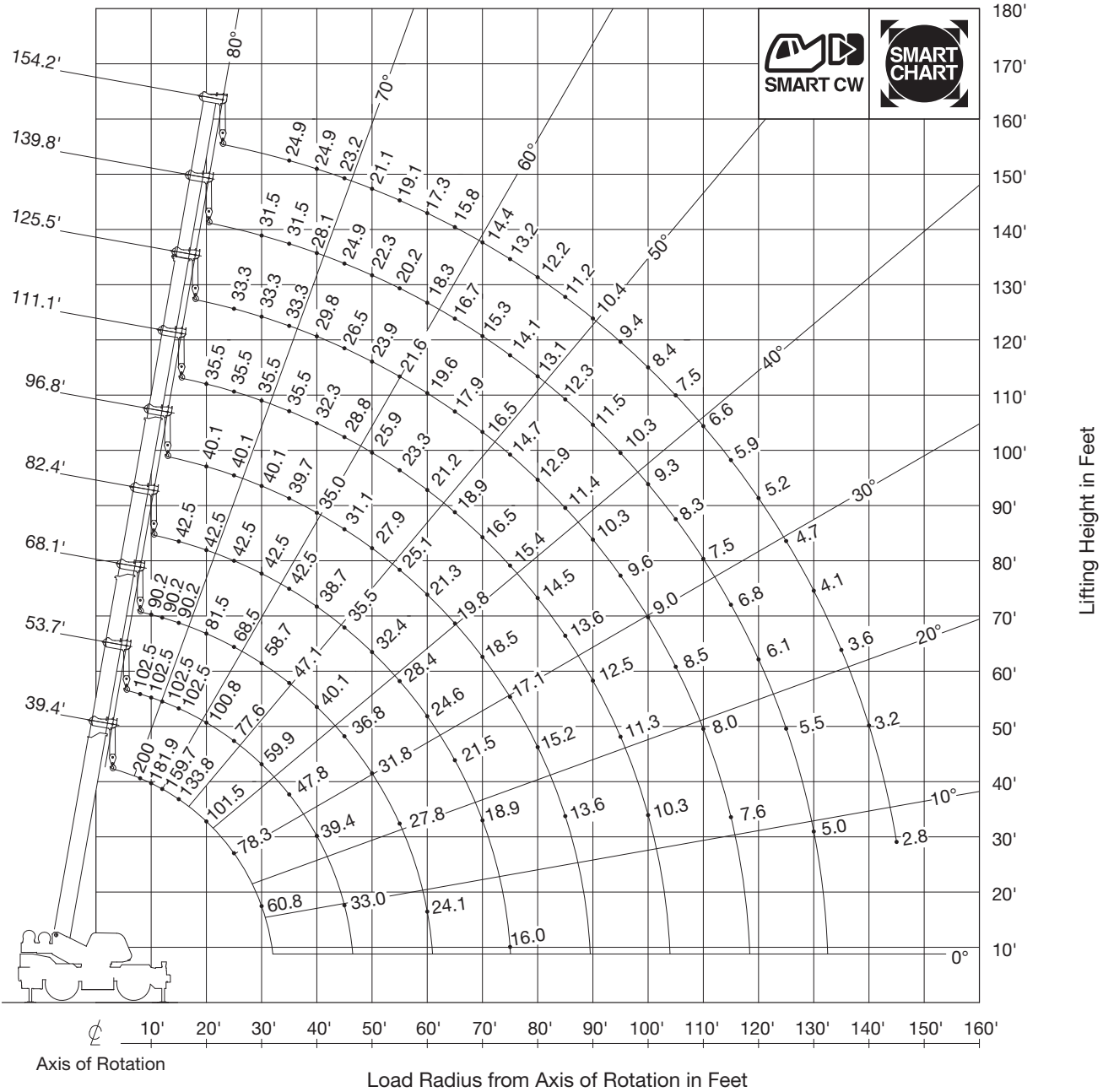

BOOM

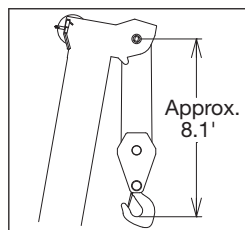

SINGLE TOP

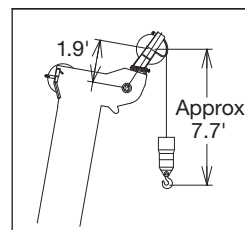

NOTE: Boom geometry shown is for unloaded condition and machine standing level on firm supporting surface. Boom deflection and subsequent radius and boom angle change must be accounted for when applying load to hook. When boom length is same as telescoping mode 1 and 2, it show large load.

Operation

Fully extended – 360° – Smart Chart / SMART CW2

20,100 lb		23' 11-3/8" spread												360°			
		39.4'	53.7'	68.1'	68.1'	82.4'	82.4'	96.8'	96.8'	111.1'	111.1'	125.5'	125.5'	139.8'	139.8'	154.2'	
ft	1,000 lb															ft	
8	200,000	102,500	-	-	-	-	-	-	-	-	-	-	-	-	-	-	8
10	181,900	102,500	90,200	40,100	-	-	-	-	-	-	-	-	-	-	-	-	10
12	159,700	102,500	90,200	40,100	-	-	-	-	-	-	-	-	-	-	-	-	12
15	133,800	102,500	90,200	40,100	42,500	35,500	-	-	-	-	-	-	-	-	-	-	15
20	101,500	100,800	81,500	40,100	42,500	35,500	40,100	33,300	35,500	32,200	-	-	-	-	-	-	20
25	78,300	77,600	68,500	40,100	42,500	35,500	40,100	33,300	35,500	32,200	33,300	32,200	-	-	-	-	25
30	60,800	59,900	58,700	40,100	42,500	35,500	40,100	33,300	35,500	32,200	33,300	28,800	31,500	28,900	-	-	30
35	-	47,800	47,100	40,100	42,500	35,500	39,700	33,300	35,500	30,800	33,300	25,500	31,500	27,200	24,900	-	35
40	-	39,400	38,600	40,100	38,700	35,500	35,000	30,500	32,300	27,600	29,800	22,800	28,100	24,500	24,900	-	40
45	-	33,000	32,300	36,800	33,900	35,500	31,100	27,600	28,800	24,900	26,500	20,700	24,900	22,200	23,200	-	45
50	-	-	27,100	31,800	28,900	32,400	27,900	25,100	25,900	22,700	23,900	18,800	22,300	20,300	21,100	-	50
55	-	-	22,400	27,800	24,100	28,400	25,100	23,100	23,300	20,800	21,600	17,300	20,200	18,700	19,100	-	55
60	-	-	18,600	24,100	20,300	24,600	21,300	21,300	21,200	19,200	19,600	15,900	18,300	17,300	17,300	-	60
65	-	-	-	-	17,300	21,500	18,200	19,800	18,900	17,700	17,900	14,800	16,700	16,100	15,800	-	65
70	-	-	-	-	14,700	18,900	15,700	18,500	16,400	16,500	16,500	13,800	15,300	15,000	14,400	-	70
75	-	-	-	-	12,700	16,800	13,600	17,100	14,200	15,400	14,700	12,700	14,100	14,000	13,200	-	75
80	-	-	-	-	-	-	11,800	15,200	12,500	14,500	12,900	11,800	13,000	13,100	12,200	-	80
85	-	-	-	-	-	-	10,300	13,600	10,900	13,600	11,400	11,000	11,700	12,300	11,200	-	85
90	-	-	-	-	-	-	-	-	9,600	12,500	10,000	10,300	10,300	11,500	10,400	-	90
95	-	-	-	-	-	-	-	-	8,400	11,300	8,900	9,600	9,200	10,300	9,400	-	95
100	-	-	-	-	-	-	-	-	7,400	10,300	7,800	9,000	8,100	9,300	8,400	-	100
105	-	-	-	-	-	-	-	-	-	-	6,900	8,500	7,200	8,300	7,500	-	105
110	-	-	-	-	-	-	-	-	-	-	6,100	8,000	6,400	7,500	6,600	-	110
115	-	-	-	-	-	-	-	-	-	-	5,400	7,600	5,700	6,800	5,900	-	115
120	-	-	-	-	-	-	-	-	-	-	-	-	5,000	6,100	5,200	-	120
125	-	-	-	-	-	-	-	-	-	-	-	-	4,400	5,500	4,700	-	125
130	-	-	-	-	-	-	-	-	-	-	-	-	3,900	5,000	4,100	-	130
135	-	-	-	-	-	-	-	-	-	-	-	-	-	-	3,600	-	135
140	-	-	-	-	-	-	-	-	-	-	-	-	-	-	3,200	-	140
145	-	-	-	-	-	-	-	-	-	-	-	-	-	-	2,800	-	145

1)	0°	0°	0°	0°	0°	0°	0°	0°	0°	0°	0°	0°	0°	8°	0°	9°
2)	1, 2	1	1	2	1	2	1	2	1	2	1	2	1	2	1, 2	2)
3.)	2.	0	50	100	0	100	0	100	0	100	0	100	0	100	50	100
	3.	0	0	0	33	16	50	33	67	50	83	67	100	83	100	100
	4.	0	0	0	33	16	50	33	67	50	83	67	100	83	100	100
	Top	0	0	0	33	16	50	33	67	50	83	67	100	83	100	100

	39.4	53.7	68.1	68.1	82.4	82.4	96.8	96.8	111.1	111.1	125.5	125.5		139.8		(ft)
	32.4	46.7	60.9	60.8	75.1	74.9	89.2	88.9	103.5	102.9	117.6	116.9		131.3		(ft)
3)	2,4100	13,800	7,300	13,300	10,200	16,100	3,600	7,300	2,400	6,200	1,800	5,200		3,300		(lb)

1)	1, 2	1	1	2	1	2	1	2	1	2	1	2		2	
----	------	---	---	---	---	---	---	---	---	---	---	---	--	---	--

- 1) Minimum boom angle (°) for indicated length (no load)
- 2) Telescopic mode
- 3) Loaded boom angle (°)

NOTE: The lifting capacity data stored in the LOAD MOMENT INDICATOR (AML-E2) is based on the standard number of parts of line listed in the chart. Standard number of parts of line for each boom length should be according to the following table:



SMART CW2

Smart Chart

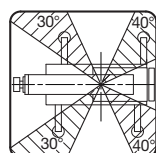

	39.4'	39.4' to 68.1'	68.1' to 154.2'	Single top jib
1)	1, 2	1	2	1, 2
	16	8	4	4

On rubber stationary – SMART CW1

20,100 lb		0°*			
ft	39.4'	68.1'	82.4'	96.8'	
1,000 lb					
12	64,300	-	-	-	
15	53,000	-	-	-	
20	40,000	35,000	28,400	-	
25	30,500	33,300	28,400	24,700	
30	21,900	24,800	25,200	24,700	
35	-	19,100	19,600	20,000	
40	-	15,100	15,600	16,000	
45	-	12,100	12,600	13,000	
50	-	9,900	10,300	10,700	
55	-	8,000	8,600	8,900	
60	-	6,600	7,100	7,400	
65	-	-	5,900	6,200	
70	-	-	4,900	5,200	
75	-	-	4,100	4,300	
80	-	-	-	3,500	
85	-	-	-	2,900	
1)	0°	0°	0°	0°	
2)	1, 2	2	2	2	
2.)	0	0	0	0	
3.)	0	33	50	67	
4.)	0	33	50	67	
Top	0	33	50	67	
	39.4'	68.1'	82.4'	96.8'	
	32.4'	60.8'	74.9'	88.9'	
3)	15,500	6,500	4,100	2,700	
0°					

20,100 lb		360°			
ft	39.4'	68.1'	82.4'	96.8'	
1,000 lb					
12	40,900	-	-	-	
15	31,700	-	-	-	
20	19,200	22,400	22,400	-	
25	12,500	15,400	16,000	16,400	
30	8,200	11,000	11,600	12,000	
35	-	8,000	8,600	8,900	
40	-	5,800	6,400	6,700	
45	-	4,200	4,700	5,000	
50	-	2,900	3,400	3,700	
55	-	1,900	2,400	2,700	
60	-	-	1,500	1,800	
65	-	-	-	-	
70	-	-	-	-	
75	-	-	-	-	
80	-	-	-	-	
85	-	-	-	-	
1)	0°	11°	31°	39°	
2)	1, 2	2	2	2	
2.)	0	0	0	0	
3.)	0	33	50	67	
4.)	0	33	50	67	
Top	0	33	50	67	
	39.4'				
	32.4'				
3)	5,300				
0°					

- 1) Minimum boom angle (°) for indicated length (no load)
- 2) Telescopic mode
- 3) Loaded boom angle (°)
- * over front

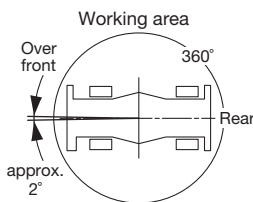

NOTE:

The lifting capacity data stored in the LOAD MOMENT INDICATOR (AML-E2) is based on the standard number of parts of line listed in the chart. Standard number of parts of line for on-rubber operation should be according to the chart.

	39.4'	42.0' to 96.8'	Single top jib
	6	4	1

Operation

On rubber creep – SMART CW1

20,100 lb		0° *			
	39.4'	68.1'	82.4'	96.8'	
ft	1,000 lb				
12	49,800	-	-	-	-
15	40,700	-	-	-	-
20	30,200	32,200	28,400	-	-
25	23,000	25,700	26,200	24,700	-
30	17,900	20,600	21,100	21,600	-
35	-	16,700	17,300	17,600	-
40	-	13,800	14,300	14,700	-
45	-	11,400	11,900	12,300	-
50	-	9,400	10,000	10,300	-
55	-	7,800	8,300	8,600	-
60	-	6,400	6,800	7,200	-
65	-	-	5,600	6,000	-
70	-	-	4,700	5,000	-
75	-	-	3,900	4,100	-
80	-	-	-	3,400	-
85	-	-	-	2,800	-
1)	0°	0°	0°	0°	
2)	1, 2	2	2	2	
2.	0	0	0	0	
3.	0	33	50	67	
4.	0	33	50	67	
Top	0	33	50	67	
	39.4'	68.1'	82.4'	96.8'	
	32.4'	60.8'	74.9'	88.9'	
3)	13,800	6,200	3,900	2,600	
0°					

- 1) Minimum boom angle (°) for indicated length (no load)
- 2) Telescopic mode
- 3) Loaded boom angle (°)
- * over front

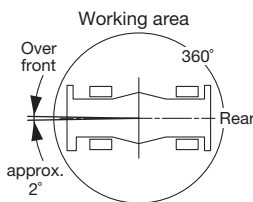

NOTE:

The lifting capacity data stored in the LOAD MOMENT INDICATOR (AML-E2) is based on the standard number of parts of line listed in the chart. Standard number of parts of line for on-rubber operation should be according to the chart.

	39.4'	42.0' to 96.8'	Single top jib
	6	4	1

On rubber stationary – SMART CW2

20,100 lb		0°*			
ft	39.4'	68.1'	82.4'	96.8'	
1,000 lb					
12	66,400	-	-	-	
15	54,900	-	-	-	
20	41,500	35,000	28,400	-	
25	32,200	34,900	28,400	24,700	
30	23,300	26,200	26,600	24,700	
35	-	20,200	20,700	21,000	
40	-	16,000	16,600	16,900	
45	-	12,900	13,500	13,800	
50	-	10,600	11,100	11,400	
55	-	8,700	9,200	9,500	
60	-	7,200	7,700	8,000	
65	-	-	6,400	6,700	
70	-	-	5,400	5,700	
75	-	-	4,500	4,800	
80	-	-	-	4,000	
85	-	-	-	3,300	
1)	0°	0°	0°	0°	
2)	1, 2	2	2	2	
3)	0	0	0	0	
4)	0	33	50	67	
Top	0	33	50	67	
	39.4'	68.1'	82.4'	96.8'	
	32.4'	60.8'	74.9'	88.9'	
3)	16,600	7,000	4,500	3,100	

20,100 lb		360°			
ft	39.4'	68.1'	82.4'	96.8'	
1,000 lb					
12	-	-	-	-	
15	-	-	-	-	
20	21,000	-	-	-	
25	13,800	16,800	-	-	
30	9,300	12,100	12,700	12,700	
35	-	9,000	9,500	9,900	
40	-	6,700	7,200	7,500	
45	-	4,900	5,400	5,800	
50	-	3,500	4,100	4,400	
55	-	2,400	3,000	3,300	
60	-	1,600	2,000	2,400	
65	-	-	-	-	
70	-	-	-	-	
75	-	-	-	-	
80	-	-	-	-	
85	-	-	-	-	
1)	0°	0°	29°	37°	
2)	1, 2	2	2	2	
3)	0	0	0	0	
4)	0	33	50	67	
Top	0	33	50	67	
	39.4'	68.1'			
	32.4'	60.8'			
3)	6,200	1,500			

- 1) Minimum boom angle (°) for indicated length (no load)
- 2) Telescopic mode
- 3) Loaded boom angle (°)
- * over front

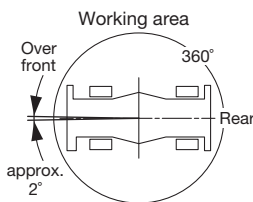

NOTE:

The lifting capacity data stored in the LOAD MOMENT INDICATOR (AML-E2) is based on the standard number of parts of line listed in the chart. Standard number of parts of line for on-rubber operation should be according to the chart.

	39.4'	42.0' to 96.8'	Single top jib
	6	4	1

Operation

On rubber creep – SMART CW2

20,100 lb		0°*			
	39.4'	68.1'	82.4'	96.8'	
ft	1,000 lb				
12	51,900	-	-	-	
15	42,600	-	-	-	
20	31,600	32,200	28,400	-	
25	24,300	27,000	27,500	24,700	
30	19,000	21,700	22,200	22,600	
35	-	17,700	18,200	18,600	
40	-	14,600	15,100	15,500	
45	-	12,100	12,700	13,000	
50	-	10,100	10,600	11,000	
55	-	8,400	9,000	9,300	
60	-	7,000	7,500	7,800	
65	-	-	6,200	6,500	
70	-	-	5,200	5,500	
75	-	-	4,300	4,600	
80	-	-	-	3,800	
85	-	-	-	3,200	
1)	0°	0°	0°	0°	
2)	1, 2	2	2	2	
2.	0	0	0	0	
3.	0	33	50	67	
4.	0	33	50	67	
Top	0	33	50	67	
	39.4'	68.1'	82.4'	96.8'	
	32.4'	60.8'	74.9'	88.9'	
3)	14,700	6,800	4,400	3,000	
0°					

- 1) Minimum boom angle (°) for indicated length (no load)
- 2) Telescopic mode
- 3) Loaded boom angle (°)
- * over front



SMART CW2

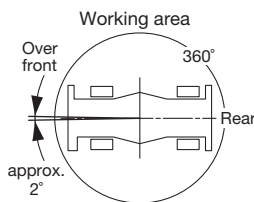

NOTE:

The lifting capacity data stored in the LOAD MOMENT INDICATOR (AML-E2) is based on the standard number of parts of line listed in the chart. Standard number of parts of line for on-rubber operation should be according to the chart.

	39.4'	42.0' to 96.8'	Single top jib
	6	4	1

Operation

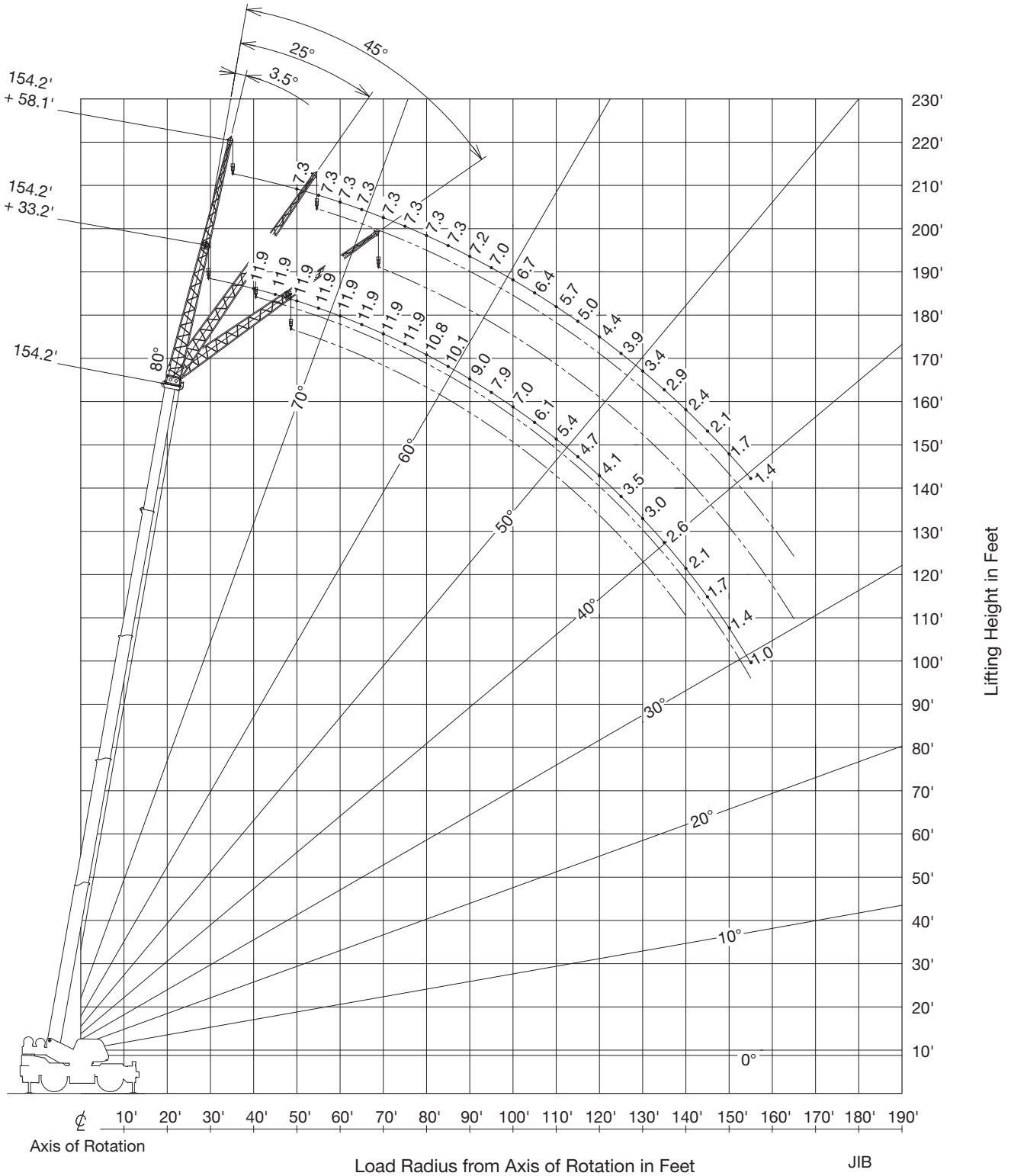

NOTE:

Jib geometry shown are for unloaded condition and machine standing level on firm supporting surface. Boom deflection and subsequent radius and boom angle change must be accounted for when applying load to hook.

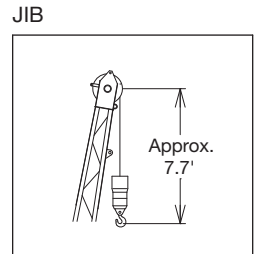

Operation

Fully extended – 360° – SMART CW1

20,100 lb				360°			
23' 11-3/8" spread				154.2' + 33.2'			
154.2' + 33.2'				154.2' + 58.1'			
	3.5°	25°	45°		3.5°	25°	45°
ft	1,000 lb			ft	1,000 lb		
40	11,900	-	-	40	-	-	-
45	11,900	-	-	45	-	-	-
50	11,900	-	-	50	7,300	-	-
55	11,900	11,900	-	55	7,300	-	-
60	11,900	11,900	10,000	60	7,300	-	-
65	11,900	11,900	9,800	65	7,300	-	-
70	11,900	11,100	9,600	70	7,300	6,200	-
75	11,900	10,400	9,400	75	7,300	6,000	-
80	10,800	9,800	9,300	80	7,300	5,900	5,100
85	10,100	9,200	8,800	85	7,300	5,700	5,000
90	9,000	8,700	8,300	90	7,200	5,600	4,900
95	7,900	8,200	7,900	95	7,000	5,400	4,800
100	7,000	7,800	7,500	100	6,700	5,300	4,800
105	6,100	6,900	7,200	105	6,400	5,200	4,700
110	5,400	6,100	6,600	110	5,700	5,100	4,600
115	4,700	5,400	5,800	115	5,000	5,000	4,500
120	4,100	4,700	5,100	120	4,400	4,900	4,500
125	3,500	4,100	4,400	125	3,900	4,800	4,400
130	3,000	3,500	3,800	130	3,400	4,400	4,400
135	2,600	3,000	3,200	135	2,900	3,800	4,300
140	2,100	2,500	2,700	140	2,400	3,300	3,900
145	1,700	2,100	-	145	2,100	2,900	3,400
150	1,400	1,700	-	150	1,700	2,400	2,900
155	1,000	1,300	-	155	1,400	2,000	2,400
160	-	-	-	160	-	1,700	2,000
165	-	-	-	165	-	1,300	1,600
1)	1, 2	1, 2	1, 2	1)	1, 2	1, 2	1, 2

1) Telescopic mode

Operation

Fully extended – 360° – SMART CW1

20,100 lb								360°							
23' 11-3/8" spread															
139.8' + 33.2'								139.8' + 58.1'							
		3.5°	3.5°	25°	25°	45°	45°			3.5°	3.5°	25°	25°	45°	45°
ft	1,000 lb							ft	1,000 lb						
35	14,100	13,000	-	-	-	-	-	35	-	-	-	-	-	-	-
40	14,100	13,000	-	-	-	-	-	40	-	-	-	-	-	-	-
45	14,100	13,000	-	-	-	-	-	45	8,200	-	-	-	-	-	-
50	14,100	13,000	13,400	13,000	-	-	-	50	8,200	7,700	-	-	-	-	-
55	14,100	13,000	12,900	12,800	10,300	-	-	55	8,200	7,700	-	-	-	-	-
60	14,100	13,000	12,400	12,200	10,000	10,000	-	60	8,200	7,700	-	-	-	-	-
65	14,100	12,500	12,000	11,400	9,800	9,700	-	65	8,200	7,700	6,500	-	-	-	-
70	14,100	11,600	11,600	10,600	9,600	9,500	-	70	8,200	7,700	6,300	6,200	-	-	-
75	13,300	10,800	11,300	9,900	9,400	9,400	-	75	8,100	7,700	6,100	6,100	-	-	-
80	11,700	10,000	10,900	9,300	9,200	8,900	-	80	7,800	7,700	6,000	5,900	5,100	5,100	-
85	10,300	9,400	10,600	8,800	9,100	8,400	-	85	7,500	7,400	5,800	5,700	5,000	5,000	-
90	9,100	8,800	10,000	8,200	8,900	8,000	-	90	7,300	7,100	5,600	5,600	5,000	4,900	-
95	8,000	8,300	8,800	7,800	8,800	7,500	-	95	7,000	6,900	5,500	5,400	4,900	4,800	-
100	7,100	7,800	7,800	7,400	8,300	7,100	-	100	6,800	6,700	5,400	5,300	4,800	4,800	-
105	6,200	7,100	6,900	7,000	7,300	6,800	-	105	6,600	6,300	5,200	5,200	4,700	4,700	-
110	5,500	6,300	6,100	6,600	6,500	6,500	-	110	6,000	5,900	5,100	5,100	4,600	4,600	-
115	4,800	5,600	5,400	6,200	5,700	6,200	-	115	5,300	5,600	5,000	5,000	4,500	4,500	-
120	4,200	5,000	4,700	5,500	4,900	5,700	-	120	4,700	5,200	4,900	4,900	4,400	4,400	-
125	3,600	4,500	4,100	4,900	4,300	5,100	-	125	4,100	4,900	4,800	4,700	4,400	4,300	-
130	3,100	3,900	3,500	4,300	3,700	4,500	-	130	3,600	4,400	4,500	4,500	4,300	4,300	-
135	2,600	3,500	3,000	3,800	-	-	-	135	3,100	3,900	4,000	4,300	4,200	4,200	-
140	2,200	3,000	2,500	3,300	-	-	-	140	2,700	3,500	3,500	4,100	3,900	4,200	-
145	1,800	2,600	2,100	2,900	-	-	-	145	2,200	3,100	3,000	3,700	3,400	4,000	-
150	1,400	2,300	1,700	2,500	-	-	-	150	1,900	2,700	2,500	3,300	2,900	3,500	-
155	1,100	1,900	1,300	2,100	-	-	-	155	1,500	2,400	2,100	2,900	-	-	-
160	-	1,600	-	-	-	-	-	160	1,200	2,100	1,800	2,500	-	-	-
165	-	-	-	-	-	-	-	165	900	1,800	1,400	2,100	-	-	-
170	-	-	-	-	-	-	-	170	-	1,500	1,100	1,800	-	-	-
175	-	-	-	-	-	-	-	175	-	1,200	-	1,500	-	-	-
180	-	-	-	-	-	-	-	180	-	1,000	-	1,200	-	-	-
1)	1	2	1	2	1	2		1)	1	2	1	2	1	2	

1) Telescopic mode

Operation

Fully extended – 360° – SMART CW1

20,100 lb								360°							
23' 11-3/8" spread															
125.5' + 33.2'								125.5' + 58.1'							
		3.5°	3.5°	25°	25°	45°	45°			3.5°	3.5°	25°	25°	45°	45°
ft	1,000 lb							ft	1,000 lb						
30	14,600	14,300	-	-	-	-	-	30	-	-	-	-	-	-	-
35	14,600	14,300	-	-	-	-	-	35	-	-	-	-	-	-	-
40	14,600	14,300	-	-	-	-	-	40	9,300	8,400	-	-	-	-	-
45	14,600	14,300	13,900	13,700	-	-	-	45	9,300	8,400	-	-	-	-	-
50	14,600	14,300	13,300	13,100	10,500	10,400	-	50	9,300	8,400	-	-	-	-	-
55	14,600	13,900	12,800	12,600	10,200	10,100	-	55	9,300	8,400	-	-	-	-	-
60	14,600	12,700	12,300	11,600	10,000	9,900	-	60	9,300	8,400	6,800	6,700	-	-	-
65	14,600	11,700	11,800	10,800	9,800	9,700	-	65	8,900	8,400	6,600	6,400	-	-	-
70	14,600	10,800	11,400	10,000	9,500	9,500	-	70	8,500	8,200	6,400	6,200	-	-	-
75	13,200	10,000	11,100	9,400	9,400	9,000	-	75	8,200	7,900	6,200	6,000	5,200	5,100	-
80	11,600	9,300	10,800	8,800	9,200	8,500	-	80	7,800	7,600	6,000	5,900	5,000	5,000	-
85	10,200	8,700	10,400	8,200	9,100	8,000	-	85	7,500	7,300	5,800	5,700	4,900	4,900	-
90	9,000	8,100	9,900	7,700	8,900	7,500	-	90	7,300	7,000	5,600	5,500	4,800	4,700	-
95	7,900	7,600	8,700	7,300	8,800	7,100	-	95	7,000	6,600	5,500	5,400	4,700	4,600	-
100	7,000	7,100	7,700	6,900	8,100	6,700	-	100	6,700	6,200	5,400	5,300	4,500	4,500	-
105	6,100	6,700	6,800	6,500	7,100	6,400	-	105	6,500	5,800	5,200	5,100	4,500	4,400	-
110	5,400	6,300	5,900	6,100	6,200	6,000	-	110	6,200	5,400	5,100	5,000	4,400	4,300	-
115	4,700	6,000	5,200	5,800	5,400	5,700	-	115	5,500	5,100	5,000	4,900	4,300	4,200	-
120	4,100	5,600	4,500	5,500	-	-	-	120	4,800	4,800	4,800	4,700	4,200	4,200	-
125	3,500	5,300	3,900	5,200	-	-	-	125	4,300	4,500	4,700	4,400	4,100	4,100	-
130	3,000	4,800	3,300	5,000	-	-	-	130	3,700	4,300	4,500	4,200	4,100	4,000	-
135	2,500	4,400	2,800	4,600	-	-	-	135	3,300	4,100	4,000	4,000	4,000	3,900	-
140	2,100	3,900	2,300	4,100	-	-	-	140	2,800	3,800	3,500	3,800	3,700	3,700	-
145	1,700	3,500	-	-	-	-	-	145	2,400	3,600	3,000	3,600	-	-	-
150	-	3,200	-	-	-	-	-	150	2,100	3,400	2,500	3,400	-	-	-
155	-	-	-	-	-	-	-	155	1,700	3,300	2,100	3,200	-	-	-
160	-	-	-	-	-	-	-	160	1,400	2,900	1,700	3,100	-	-	-
165	-	-	-	-	-	-	-	165	1,100	2,600	1,300	2,800	-	-	-
170	-	-	-	-	-	-	-	170	-	2,400	-	-	-	-	-
1)	1	2	1	2	1	2		1)	1	2	1	2	1	2	

1) Telescopic mode

Operation

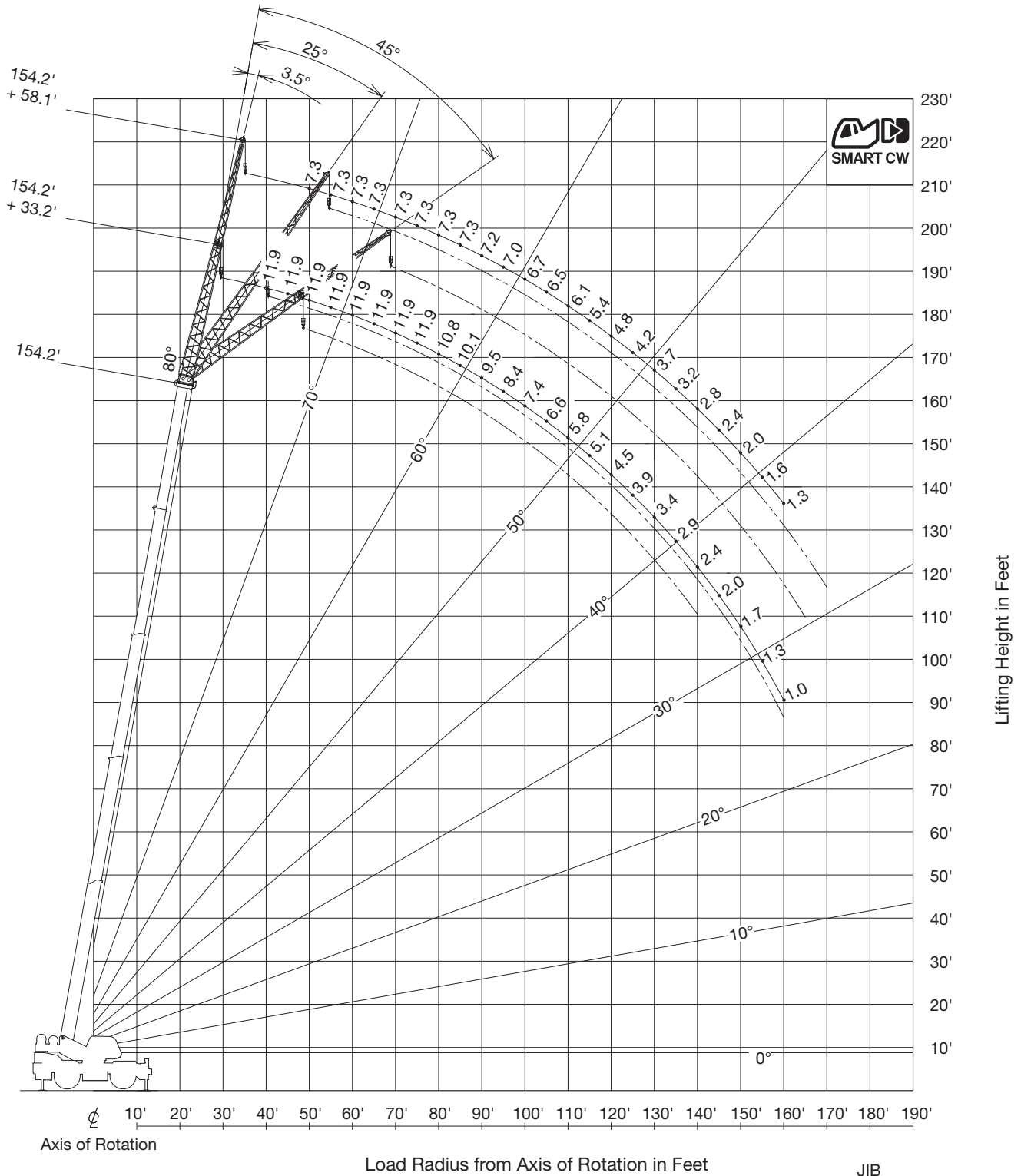

NOTE:

Jib geometry shown are for unloaded condition and machine standing level on firm supporting surface. Boom deflection and subsequent radius and boom angle change must be accounted for when applying load to hook.

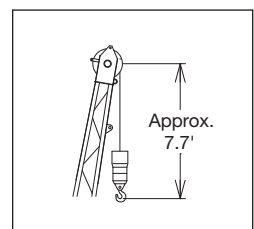

Operation

Fully extended – 360° – SMART CW2

20,100 lb				360°			
23' 11-3/8" spread				154.2' + 58.1'			
ft	3.5°	25°	45°	ft	3.5°	25°	45°
		1,000 lb				1,000 lb	
40	11,900	-	-	40	-	-	-
45	11,900	-	-	45	-	-	-
50	11,900	-	-	50	7,300	-	-
55	11,900	11,900	-	55	7,300	-	-
60	11,900	11,900	10,000	60	7,300	-	-
65	11,900	11,900	9,800	65	7,300	-	-
70	11,900	11,100	9,600	70	7,300	6,200	-
75	11,900	10,400	9,400	75	7,300	6,000	-
80	10,800	9,800	9,300	80	7,300	5,900	5,100
85	10,100	9,200	8,800	85	7,300	5,700	5,000
90	9,500	8,700	8,300	90	7,200	5,600	4,900
95	8,400	8,200	7,900	95	7,000	5,400	4,800
100	7,400	7,800	7,500	100	6,700	5,300	4,800
105	6,600	7,400	7,200	105	6,500	5,200	4,700
110	5,800	6,500	6,800	110	6,100	5,100	4,600
115	5,100	5,800	6,200	115	5,400	5,000	4,500
120	4,500	5,100	5,400	120	4,800	4,900	4,500
125	3,900	4,400	4,800	125	4,200	4,800	4,400
130	3,400	3,900	4,100	130	3,700	4,700	4,400
135	2,900	3,300	3,600	135	3,200	4,100	4,300
140	2,400	2,800	3,000	140	2,800	3,600	4,200
145	2,000	2,400	-	145	2,400	3,200	3,700
150	1,700	2,000	-	150	2,000	2,700	3,200
155	1,300	1,600	-	155	1,600	2,300	2,700
160	1,000	1,200	-	160	1,300	1,900	2,300
165	-	-	-	165	-	1,600	1,900
170	-	-	-	170	-	1,200	-
1)	1, 2	1, 2	1, 2	1)	1, 2	1, 2	1, 2

1) Telescopic mode



SMART CW2

Operation

Fully extended – 360° – SMART CW2

20,100 lb								23' 11-3/8" spread								360°							
		3.5°		25°		45°				3.5°		25°		45°				3.5°		25°		45°	
ft		1,000 lb		1,000 lb		1,000 lb		ft		1,000 lb		1,000 lb		1,000 lb		ft		1,000 lb		1,000 lb		1,000 lb	
35	14,100	13,000	-	-	-	-	-	35	-	-	-	-	-	-	-	-	35	-	-	-	-	-	-
40	14,100	13,000	-	-	-	-	-	40	-	-	-	-	-	-	-	-	40	-	-	-	-	-	-
45	14,100	13,000	-	-	-	-	-	45	8,200	-	-	-	-	-	-	-	45	8,200	-	-	-	-	-
50	14,100	13,000	13,400	13,000	-	-	-	50	8,200	7,700	-	-	-	-	-	-	50	8,200	7,700	-	-	-	-
55	14,100	13,000	12,900	12,800	10,300	-	-	55	8,200	7,700	-	-	-	-	-	-	55	8,200	7,700	-	-	-	-
60	14,100	13,000	12,400	12,200	10,000	10,000	-	60	8,200	7,700	-	-	-	-	-	-	60	8,200	7,700	-	-	-	-
65	14,100	12,500	12,000	11,400	9,800	9,700	-	65	8,200	7,700	6,500	-	-	-	-	-	65	8,200	7,700	6,500	-	-	-
70	14,100	11,600	11,600	10,600	9,600	9,500	-	70	8,200	7,700	6,300	6,200	-	-	-	-	70	8,200	7,700	6,300	6,200	-	-
75	13,600	10,800	11,300	9,900	9,400	9,400	-	75	8,100	7,700	6,100	6,100	-	-	-	-	75	8,100	7,700	6,100	6,100	-	-
80	12,200	10,000	10,900	9,300	9,200	8,900	-	80	7,800	7,700	6,000	5,900	5,100	5,100	-	-	80	7,800	7,700	6,000	5,900	5,100	5,100
85	10,800	9,400	10,600	8,800	9,100	8,400	-	85	7,500	7,400	5,800	5,700	5,000	5,000	-	-	85	7,500	7,400	5,800	5,700	5,000	5,000
90	9,500	8,800	10,300	8,200	8,900	8,000	-	90	7,300	7,100	5,600	5,600	5,000	4,900	-	-	90	7,300	7,100	5,600	5,600	5,000	4,900
95	8,400	8,300	9,300	7,800	8,800	7,500	-	95	7,000	6,900	5,500	5,400	4,900	4,800	-	-	95	7,000	6,900	5,500	5,400	4,900	4,800
100	7,500	7,800	8,200	7,400	8,700	7,100	-	100	6,800	6,700	5,400	5,300	4,800	4,800	-	-	100	6,800	6,700	5,400	5,300	4,800	4,800
105	6,600	7,300	7,300	7,000	7,700	6,800	-	105	6,600	6,300	5,200	5,200	4,700	4,700	-	-	105	6,600	6,300	5,200	5,200	4,700	4,700
110	5,800	6,700	6,500	6,600	6,800	6,500	-	110	6,400	5,900	5,100	5,100	4,600	4,600	-	-	110	6,400	5,900	5,100	5,100	4,600	4,600
115	5,100	6,000	5,700	6,300	6,000	6,200	-	115	5,700	5,600	5,000	5,000	4,500	4,500	-	-	115	5,700	5,600	5,000	5,000	4,500	4,500
120	4,500	5,400	5,000	5,800	5,300	5,900	-	120	5,000	5,200	4,900	4,900	4,400	4,400	-	-	120	5,000	5,200	4,900	4,900	4,400	4,400
125	3,900	4,800	4,400	5,200	4,600	5,400	-	125	4,400	5,000	4,800	4,700	4,400	4,300	-	-	125	4,400	5,000	4,800	4,700	4,400	4,300
130	3,400	4,200	3,800	4,600	4,000	4,800	-	130	3,900	4,700	4,700	4,500	4,300	4,300	-	-	130	3,900	4,700	4,700	4,500	4,300	4,300
135	2,900	3,700	3,300	4,100	-	-	-	135	3,400	4,300	4,300	4,300	4,200	4,200	-	-	135	3,400	4,300	4,300	4,300	4,200	4,200
140	2,500	3,300	2,800	3,600	-	-	-	140	3,000	3,800	3,800	4,100	4,200	4,200	-	-	140	3,000	3,800	3,800	4,100	4,200	4,200
145	2,100	2,900	2,300	3,100	-	-	-	145	2,600	3,400	3,300	3,900	3,600	4,000	-	-	145	2,600	3,400	3,300	3,900	3,600	4,000
150	1,700	2,500	1,900	2,700	-	-	-	150	2,200	3,000	2,800	3,500	3,200	3,800	-	-	150	2,200	3,000	2,800	3,500	3,200	3,800
155	1,300	2,200	1,500	2,300	-	-	-	155	1,800	2,600	2,400	3,100	-	-	-	-	155	1,800	2,600	2,400	3,100	-	-
160	1,000	1,900	-	-	-	-	-	160	1,500	2,300	2,000	2,700	-	-	-	-	160	1,500	2,300	2,000	2,700	-	-
165	-	-	-	-	-	-	-	165	1,200	2,000	1,700	2,400	-	-	-	-	165	1,200	2,000	1,700	2,400	-	-
170	-	-	-	-	-	-	-	170	-	1,700	1,300	2,000	-	-	-	-	170	-	1,700	1,300	2,000	-	-
175	-	-	-	-	-	-	-	175	-	1,500	-	1,700	-	-	-	-	175	-	1,500	-	1,700	-	-
180	-	-	-	-	-	-	-	180	-	1,200	-	1,400	-	-	-	-	180	-	1,200	-	1,400	-	-
1)	1	2	1	2	1	2		1)	1	2	1	2	1	2		1)	1	2	1	2	1	2	

1) Telescopic mode



SMART CW2

Operation

Fully extended – 360° – SMART CW2

20,100 lb								360°							
23' 11-3/8" spread															
125.5' + 33.2'								125.5' + 58.1'							
3.5° 3.5° 25° 25° 45° 45°								3.5° 3.5° 25° 25° 45° 45°							
ft	1,000 lb							ft	1,000 lb						
30	14,600	14,300	-	-	-	-	-	30	-	-	-	-	-	-	-
35	14,600	14,300	-	-	-	-	-	35	-	-	-	-	-	-	-
40	14,600	14,300	-	-	-	-	-	40	9,300	8,400	-	-	-	-	-
45	14,600	14,300	13,900	13,700	-	-	-	45	9,300	8,400	-	-	-	-	-
50	14,600	14,300	13,300	13,100	10,500	10,400	-	50	9,300	8,400	-	-	-	-	-
55	14,600	13,900	12,800	12,600	10,200	10,100	-	55	9,300	8,400	-	-	-	-	-
60	14,600	12,700	12,300	11,600	10,000	9,900	-	60	9,300	8,400	6,800	6,700	-	-	-
65	14,600	11,700	11,800	10,800	9,800	9,700	-	65	8,900	8,400	6,600	6,400	-	-	-
70	14,600	10,800	11,400	10,000	9,500	9,500	-	70	8,500	8,200	6,400	6,200	-	-	-
75	13,700	10,000	11,100	9,400	9,400	9,000	-	75	8,200	7,900	6,200	6,000	5,200	5,100	-
80	12,100	9,300	10,800	8,800	9,200	8,500	-	80	7,800	7,600	6,000	5,900	5,000	5,000	-
85	10,600	8,700	10,400	8,200	9,100	8,000	-	85	7,500	7,300	5,800	5,700	4,900	4,900	-
90	9,400	8,100	10,200	7,700	8,900	7,500	-	90	7,300	7,000	5,600	5,500	4,800	4,700	-
95	8,300	7,600	9,100	7,300	8,800	7,100	-	95	7,000	6,600	5,500	5,400	4,700	4,600	-
100	7,400	7,100	8,100	6,900	8,500	6,700	-	100	6,700	6,200	5,400	5,300	4,500	4,500	-
105	6,500	6,700	7,100	6,500	7,500	6,400	-	105	6,500	5,800	5,200	5,100	4,500	4,400	-
110	5,700	6,300	6,300	6,100	6,600	6,000	-	110	6,300	5,400	5,100	5,000	4,400	4,300	-
115	5,000	6,000	5,500	5,800	5,800	5,700	-	115	5,800	5,100	5,000	4,900	4,300	4,200	-
120	4,400	5,600	4,800	5,500	-	-	-	120	5,200	4,800	4,800	4,700	4,200	4,200	-
125	3,800	5,300	4,200	5,200	-	-	-	125	4,600	4,500	4,700	4,400	4,100	4,100	-
130	3,300	5,100	3,600	5,000	-	-	-	130	4,000	4,300	4,600	4,200	4,100	4,000	-
135	2,800	4,700	3,100	4,700	-	-	-	135	3,500	4,100	4,300	4,000	4,000	3,900	-
140	2,400	4,200	2,600	4,400	-	-	-	140	3,100	3,800	3,700	3,800	4,000	3,700	-
145	2,000	3,800	-	-	-	-	-	145	2,700	3,600	3,200	3,600	-	-	-
150	-	3,400	-	-	-	-	-	150	2,300	3,400	2,800	3,400	-	-	-
155	-	-	-	-	-	-	-	155	1,900	3,300	2,400	3,200	-	-	-
160	-	-	-	-	-	-	-	160	1,600	3,100	2,000	3,100	-	-	-
165	-	-	-	-	-	-	-	165	1,300	2,900	1,600	2,900	-	-	-
170	-	-	-	-	-	-	-	170	1,000	2,600	-	-	-	-	-
1)	1	2	1	2	1	2		1)	1	2	1	2	1	2	

1) Telescopic mode



SMART CW2

Operation

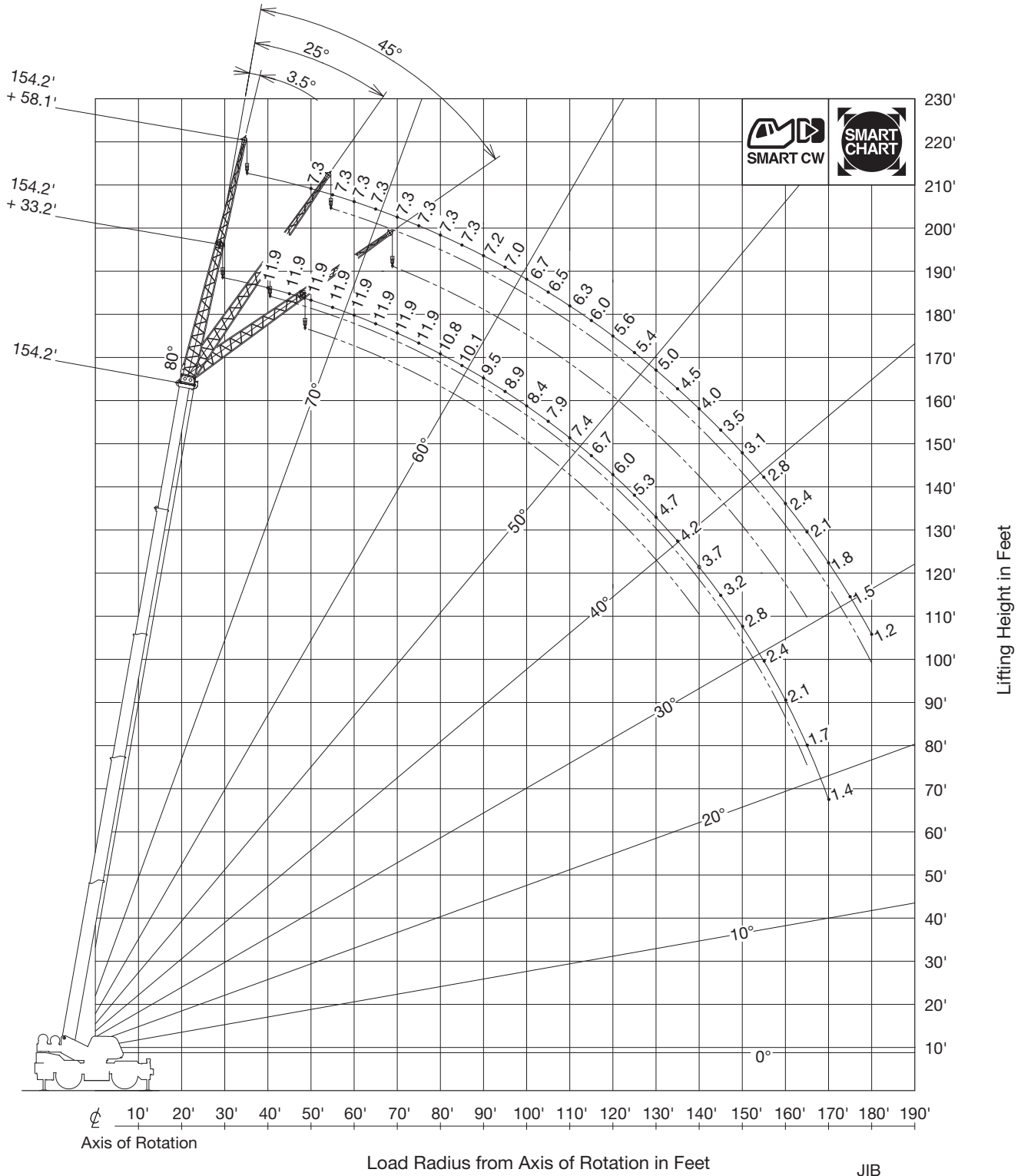

NOTE:

Jib geometry shown are for unloaded condition and machine standing level on firm supporting surface. Boom deflection and subsequent radius and boom angle change must be accounted for when applying load to hook.

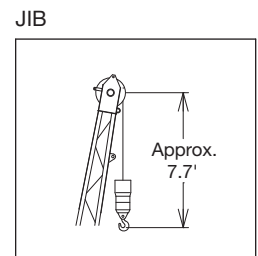

Operation

Fully extended – 360° – Smart Chart / SMART CW2

20,100 lb				360°			
23' 11-3/8" spread							
154.2' + 33.2'				154.2' + 58.1'			
ft	3.5°	25°	45°	ft	3.5°	25°	45°
1,000 lb				1,000 lb			
40	11,900	-	-	40	-	-	-
45	11,900	-	-	45	-	-	-
50	11,900	-	-	50	7,300	-	-
55	11,900	11,900	-	55	7,300	-	-
60	11,900	11,900	10,000	60	7,300	-	-
65	11,900	11,900	9,800	65	7,300	-	-
70	11,900	11,100	9,600	70	7,300	6,200	-
75	11,900	10,400	9,400	75	7,300	6,000	-
80	10,800	9,800	9,300	80	7,300	5,900	5,100
85	10,100	9,200	8,800	85	7,300	5,700	5,000
90	9,500	8,700	8,300	90	7,200	5,600	4,900
95	8,900	8,200	7,900	95	7,000	5,400	4,800
100	8,400	7,800	7,500	100	6,700	5,300	4,800
105	7,900	7,400	7,200	105	6,500	5,200	4,700
110	7,400	7,100	6,800	110	6,300	5,100	4,600
115	6,700	6,700	6,500	115	6,000	5,000	4,500
120	6,000	6,400	6,200	120	5,600	4,900	4,500
125	5,300	5,900	6,000	125	5,400	4,800	4,400
130	4,700	5,200	5,400	130	5,000	4,700	4,400
135	4,200	4,600	4,800	135	4,500	4,500	4,300
140	3,700	4,100	4,300	140	4,000	4,300	4,300
145	3,200	3,600	-	145	3,500	4,100	4,300
150	2,800	3,100	-	150	3,100	3,900	4,200
155	2,400	2,700	-	155	2,800	3,400	3,800
160	2,100	2,300	-	160	2,400	3,000	3,400
165	1,700	1,900	-	165	2,100	2,600	2,900
170	1,400	-	-	170	1,800	2,200	-
175	-	-	-	175	1,500	1,900	-
180	-	-	-	180	1,200	1,600	-
1)	1, 2	1, 2	1, 2	1)	1, 2	1, 2	1, 2

1) Telescopic mode

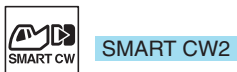

Operation

Fully extended – 360° – Smart Chart / SMART CW2

20,100 lb								360°							
23' 11-3/8" spread															
139.8' + 33.2'								139.8' + 58.1'							
	3.5°	3.5°	25°	25°	45°	45°		3.5°	3.5°	25°	25°	45°	45°		
ft	1,000 lb							ft	1,000 lb						
35	14,100	13,000	-	-	-	-	35	-	-	-	-	-	-		
40	14,100	13,000	-	-	-	-	40	-	-	-	-	-	-		
45	14,100	13,000	-	-	-	-	45	8,200	-	-	-	-	-		
50	14,100	13,000	13,400	13,000	-	-	50	8,200	7,700	-	-	-	-		
55	14,100	13,000	12,900	12,800	10,300	-	55	8,200	7,700	-	-	-	-		
60	14,100	13,000	12,400	12,200	10,000	10,000	60	8,200	7,700	-	-	-	-		
65	14,100	12,500	12,000	11,400	9,800	9,700	65	8,200	7,700	6,500	-	-	-		
70	14,100	11,600	11,600	10,600	9,600	9,500	70	8,200	7,700	6,300	6,200	-	-		
75	13,600	10,800	11,300	9,900	9,400	9,400	75	8,100	7,700	6,100	6,100	-	-		
80	12,500	10,000	10,900	9,300	9,200	8,900	80	7,800	7,700	6,000	5,900	5,100	5,100		
85	11,500	9,400	10,600	8,800	9,100	8,400	85	7,500	7,400	5,800	5,700	5,000	5,000		
90	10,600	8,800	10,300	8,200	8,900	8,000	90	7,300	7,100	5,600	5,600	5,000	4,900		
95	9,800	8,300	10,000	7,800	8,800	7,500	95	7,000	6,900	5,500	5,400	4,900	4,800		
100	9,100	7,800	9,300	7,400	8,700	7,100	100	6,800	6,700	5,400	5,300	4,800	4,800		
105	8,300	7,300	8,600	7,000	8,600	6,800	105	6,600	6,300	5,200	5,200	4,700	4,700		
110	7,400	6,900	8,000	6,600	8,100	6,500	110	6,400	5,900	5,100	5,100	4,600	4,600		
115	6,600	6,600	7,200	6,300	7,500	6,200	115	6,200	5,600	5,000	5,000	4,500	4,500		
120	5,900	6,200	6,400	6,000	6,700	5,900	120	6,000	5,200	4,900	4,900	4,400	4,400		
125	5,300	5,900	5,700	5,700	5,900	5,600	125	5,800	5,000	4,800	4,700	4,400	4,300		
130	4,700	5,500	5,100	5,400	5,200	5,400	130	5,300	4,700	4,700	4,500	4,300	4,300		
135	4,100	5,000	4,500	5,200	-	-	135	4,700	4,500	4,500	4,300	4,200	4,200		
140	3,600	4,500	3,900	4,800	-	-	140	4,200	4,200	4,500	4,100	4,200	4,200		
145	3,200	4,000	3,400	4,300	-	-	145	3,800	4,000	4,300	3,900	4,100	4,000		
150	2,800	3,600	3,000	3,800	-	-	150	3,400	3,800	3,900	3,700	4,100	3,800		
155	2,400	3,200	2,500	3,400	-	-	155	3,000	3,600	3,500	3,500	-	-		
160	2,000	2,800	-	-	-	-	160	2,600	3,300	3,100	3,400	-	-		
165	-	-	-	-	-	-	165	2,200	3,000	2,600	3,200	-	-		
170	-	-	-	-	-	-	170	1,900	2,600	2,300	3,000	-	-		
175	-	-	-	-	-	-	175	1,600	2,400	1,900	2,600	-	-		
180	-	-	-	-	-	-	180	1,300	2,100	1,500	2,200	-	-		

1) Telescopic mode



SMART CW2



Smart Chart

Operation

Fully extended – 360° – Smart Chart / SMART CW2

20,100 lb								360°							
23' 11-3/8" spread								125.5' + 58.1'							
125.5' + 33.2'								125.5' + 58.1'							
3.5° 3.5° 25° 25° 45° 45°								3.5° 3.5° 25° 25° 45° 45°							
ft								ft							
1,000 lb								1,000 lb							
30	14,600	14,300	-	-	-	-	-	30	-	-	-	-	-	-	-
35	14,600	14,300	-	-	-	-	-	35	-	-	-	-	-	-	-
40	14,600	14,300	-	-	-	-	-	40	9,300	8,400	-	-	-	-	-
45	14,600	14,300	13,900	13,700	-	-	-	45	9,300	8,400	-	-	-	-	-
50	14,600	14,300	13,300	13,100	10,500	10,400	-	50	9,300	8,400	-	-	-	-	-
55	14,600	13,900	12,800	12,600	10,200	10,100	-	55	9,300	8,400	-	-	-	-	-
60	14,600	12,700	12,300	11,600	10,000	9,900	-	60	9,300	8,400	6,800	6,700	-	-	-
65	14,600	11,700	11,800	10,800	9,800	9,700	-	65	8,900	8,400	6,600	6,400	-	-	-
70	14,600	10,800	11,400	10,000	9,500	9,500	-	70	8,500	8,200	6,400	6,200	-	-	-
75	14,300	10,000	11,100	9,400	9,400	9,000	-	75	8,200	7,900	6,200	6,000	5,200	5,100	-
80	13,200	9,300	10,800	8,800	9,200	8,500	-	80	7,800	7,600	6,000	5,900	5,000	5,000	-
85	12,200	8,700	10,400	8,200	9,100	8,000	-	85	7,500	7,300	5,800	5,700	4,900	4,900	-
90	11,300	8,100	10,200	7,700	8,900	7,500	-	90	7,300	7,000	5,600	5,500	4,800	4,700	-
95	10,300	7,600	9,900	7,300	8,800	7,100	-	95	7,000	6,600	5,500	5,400	4,700	4,600	-
100	9,100	7,100	9,700	6,900	8,700	6,700	-	100	6,700	6,200	5,400	5,300	4,500	4,500	-
105	8,200	6,700	8,800	6,500	8,600	6,400	-	105	6,500	5,800	5,200	5,100	4,500	4,400	-
110	7,300	6,300	7,900	6,100	8,200	6,000	-	110	6,300	5,400	5,100	5,000	4,400	4,300	-
115	6,500	6,000	7,000	5,800	7,300	5,700	-	115	6,100	5,100	5,000	4,900	4,300	4,200	-
120	5,800	5,600	6,300	5,500	-	-	-	120	5,900	4,800	4,800	4,700	4,200	4,200	-
125	5,200	5,300	5,600	5,200	-	-	-	125	5,800	4,500	4,700	4,400	4,100	4,100	-
130	4,600	5,100	4,900	5,000	-	-	-	130	5,300	4,300	4,600	4,200	4,100	4,000	-
135	4,000	4,800	4,300	4,700	-	-	-	135	4,800	4,100	4,500	4,000	4,000	3,900	-
140	3,500	4,600	3,700	4,500	-	-	-	140	4,300	3,800	4,400	3,800	4,000	3,700	-
145	3,100	4,400	-	-	-	-	-	145	3,800	3,600	4,300	3,600	-	-	-
150	-	4,200	-	-	-	-	-	150	3,400	3,400	3,900	3,400	-	-	-
155	-	-	-	-	-	-	-	155	3,000	3,300	3,400	3,200	-	-	-
160	-	-	-	-	-	-	-	160	2,600	3,100	3,000	3,100	-	-	-
165	-	-	-	-	-	-	-	165	2,300	3,000	-	2,900	-	-	-
170	-	-	-	-	-	-	-	170	2,000	2,800	-	-	-	-	-
1)	1	2	1	2	1	2		1)	1	2	1	2	1	2	

1) Telescopic mode



SMART CW2



Smart Chart

Notes to Lifting Capacity

GENERAL

1. RATED LIFTING CAPACITIES apply only to the machine as originally manufactured and normally equipped by TADANO LTD. Modifications to the machine or use of optional equipment other than that specified can result in a reduction of capacity.
2. Hydraulic cranes can be hazardous if improperly operated or maintained. Operation and maintenance of this machine must be in compliance with information, in the operation manual supplied with the crane. If this manual is missing, order a replacement through the distributor.
3. The operator and other personnel associated with this machine shall fully acquaint themselves with the latest American National Standards Institute (ANSI) safety standards for cranes.

SET UP

1. Rated lifting capacities on the chart are the maximum allowable crane capacities and are based on the machine standing level on firm supporting surface under ideal job conditions. Depending on the nature of the supporting surface, it may be necessary to have structural supports under the outrigger floats or tires to spread the loads to a larger bearing surface.
2. For outrigger operation, outriggers shall be properly extended with tires free of supporting surface before operating crane.

OPERATION

1. Rated lifting capacities have been tested to and meet minimum requirements of SAE J1063-Cantilevered Boom Crane Structures Method of Test. Rated lifting capacities do not exceed 85% of the tipping load on outriggers fully extended as determined by SAE J765-Crane Stability Test Code.
2. Rated lifting capacities for partially extended outriggers are determined from the formula, rated lifting capacities = (tipping load - 0.1 × tip reaction) / 1.25.
3. Rated lifting capacities are based on actual load radius increased by boom deflection.
4. The weight of handling device such as hook blocks, slings, etc., must be considered as part of the load and must be deducted from the lifting capacities.
5. Rated lifting capacities are based on freely suspended loads and make no allowance for such factors as the effect of wind, sudden stopping of loads, supporting surface conditions, inflation of tires, operating speeds, side loads, etc. Side pull on boom or jib is extremely dangerous. Such action can damage the boom, jib or slewing mechanism, and lead to overturning of the crane.
6. Rated lifting capacities do not account for wind on lifted load or boom. We recommend against working under the condition that the load is out of control due to a strong wind. During boom lift, consider that the rated lifting capacity is reduced by 50% when the wind speed is 20 mph to 27 mph; reduced by 70% when the wind speed is 27 mph to 31 mph. If the wind speed is 31 mph or over, stop operation. During jib lift, stop operation if the wind speed is 20 mph or over.
7. Rated lifting capacities at load radius shall not be exceeded. Do not tip the crane to determine allowable loads.
8. Do not operate at boom lengths, radii, or boom angle, where no capacities are shown. Crane may overturn without any load on the hook.
9. When boom length is between values listed, refer to the rated lifting capacities of the next longer and next shorter booms for the same radius. The lesser of the two rated lifting capacities shall be used.
10. When making lifts at a load radius not shown, use the next longer radius to determine allowable capacity.
11. Load per line should not exceed 14,600 lb for main winch and auxiliary winch.
12. Check the actual number of parts of line with LOAD MOMENT INDICATOR (AML-E2) before operation. Maximum lifting capacity is restricted by the number of parts of line of LOAD MOMENT INDICATOR (AML-E2). Limited capacity is as determined from the formula, single line pull for main winch 14,600 lb × number of parts of line.
13. The boom angle before loading should be greater to account for deflection. For rated lifting capacities, the loaded boom angle and the load radius is for reference only.
14. The 39.4' boom length capacities are based on boom fully retracted. If not fully retracted [less than 53.7' boom length], use the rated lifting capacities for the 53.7' boom length.
15. Extension or retraction of the boom with loads may be attempted within the limits of the RATED LIFTING CAPACITIES. The ability to telescope loads is limited by hydraulic pressure, boom angle, boom length, crane maintenance, etc. For lifting capacity of single top, deduct the weight of the load handling equipment from the rated lifting capacity of the boom.
16. For the lifting capacity of single top, the net capacity shall not exceed 14,600 lb including the main boom hook mass attached to the boom.
17. When the base jib or top jib or both jibs are removed, set the jib state switch to the REMOVED position.
18. When erecting and stowing jib, be sure to retain it by hand or by other means to prevent its free movement.
19. Use "ANTI-TWO BLOCK" disable switch when erecting and stowing jib and when stowing hook block. While the switch is pushed, the hoist does not stop, even when overwind condition occurs.
20. When lifting a load by using jib (aux. winch) and boom (main winch) simultaneously, do the following:
 - Enter the operation status as jib operation, not as boom operation.
 - Before starting operation, make sure that mass of load is within rated lifting capacity for jib.
21. Before telescoping the boom, set the telescoping mode selector switch to mode 1 or mode 2 fully retracted. A change of the telescoping mode is not permissible when the boom has been partially or fully extended.
22. Crane operation is prohibited without full counterweight 20,100 lb installed. Outriggers shall be extended 23' 11-3/8" spread when installing or removing removable counterweight.

DEFINITIONS

1. Load radius: Horizontal distance from a projection of the axis of rotation to supporting surface before loading to the center of the vertical hoist line or tackle with load applied.
2. Loaded boom angle: The angle between the boom base section and the horizontal, after lifting the rated lifting capacity at the load radius.
3. Working area: Area measured in a circular arc about the centerline of rotation.
4. Freely suspended load: Load hanging free with no direct external force applied except by the hoist line.
5. Side load: Horizontal side force applied to the lifted load either on the ground or in the air.

Warning and Operating Instructions

Notes for on Rubber Lifting Capacities

1. Rated lifting capacities on-rubber are in pounds and do not exceed 75% of tipping loads as determined by SAE J765-Crane Stability Test Code.
2. Rated lifting capacities shown in the chart are based on condition that crane is set on firm level surfaces with suspension-lock applied. They are based on actual load radius increased by tire deformation and boom deflection.
3. If the suspension-lock cylinders contain air, the axle will not be locked completely and rated lifting capacities may not be obtainable. Bleed the cylinders according to the operation safety and maintenance manual.
4. Rated lifting capacities are based on proper tire inflation, capacity and condition. Damaged tires are hazardous to safe operation of crane.
5. Tires shall be inflated to correct air pressure. Tires: 29.5-25 36PR – air pressure: 68 psi · Tires: 29.5-25 40PR – air pressure: 67 psi.
6. Over front operation shall be performed within 2 degrees in front of chassis.
7. On-rubber lifting with "jib" is not permitted. Maximum permissible boom length is 96.8 ft.
8. When making lift on-rubber stationary, set parking brake.
9. For creep operation, boom must be centered over front of machine, slewing lock engaged, and load restrained from slewing. Travel slowly and keep the lifted load as close to the ground as possible, and especially avoid any abrupt steering, accelerating or braking.
10. Do not operate the crane while carrying the load.
11. Creep is motion for crane not to travel more than 200 ft in any 30 minute period and to travel at the speed of less than 1 mph.
12. For creep operation, choose the drive mode and proper gear according to the road or working condition.

Notes for Load Moment Indicator (AML-E2)

1. Set AML select keys in accordance with the actually operating crane conditions and don't fail to make sure, before crane operation, that the displays on front panel are correct.
2. When operating crane on outriggers:
 - Set "P.T.O." switch to "ON"
 - Press the outrigger state select key to register for the outrigger operation. If the display agrees with the actual state, press the set key to register. After the completion of the registration, the display returns to the crane operation status.
 - Press the lift state select key to register the lift state to be used (single top/jib/boom).
 - Each time the lift state select key is pressed, the display changes. If the display agrees with the actual state, press the set key to register. After the completion of the registration, the display returns to the crane operation status.
 - When erecting and stowing jib, select the status of jib set (jib state indicative symbol lights up).
3. When operating crane on-rubber:
 - Set "P.T.O." switch to "ON"
 - Press the outrigger state select key to register for the on-rubber operation. Each time the outrigger state select key is pressed, the display changes. Select the creep operation, the on-rubber state indicator symbol lights up.
 - Press the lift state select key to register the lift state.However, pay attention to the following.
 - (1) For stationary operation.
 - The front capacities are attainable only when the over front position symbol comes on.
 - When the boom is more than 2 degrees from centered over front of chassis, 360° capacities are in effect.
 - When a load is lifted in the front position and then slewed to the side area, make sure the value of the LOAD MOMENT INDICATOR (AML-E2) is below the 360° lifting capacity.
 - (2) For creep operation.
 - The creep capacities are attainable only when boom is in the straight forward position of chassis and the over front position symbol is on.
 - If boom is not in the straight forward position of chassis, never lift load.
4. This machine is equipped with an automatic slewing stopping device (for the details, see operation manual). But, operate very carefully because the automatic slewing stop does not work in the following cases.
 - During on-rubber operation.
 - When the "P.T.O." switch is set to "OVERRIDE" and the "OVERRIDE" key switch outside the cab is on.
5. During crane operation, make sure that the displays on front panel are in accordance with actual operating conditions.
6. The displayed values of LOAD MOMENT INDICATOR (AML-E2) are based on freely suspended loads and make no allowance for such factors as the effect of wind, sudden stopping of loads, supporting surface conditions, inflation of tire, operating speed, side loads, etc. For safe operation, it is recommended when extending and lowering boom or slewing, lifting loads shall be appropriately reduced.
7. LOAD MOMENT INDICATOR (AML-E2) is intended as an aid to the operator. Under no condition should it be relied upon to replace use of capacity charts and operating instruction. Sole reliance upon LOAD MOMENT INDICATOR (AML-E2) aids in place of good operating practice can cause an accident. The operator must exercise caution to assure safety.
8. The lifting capacity differs depending on the outrigger extension width and slewing position. Work with the capacity corresponding to the outrigger extension width and slewing position. For the relationship among the outrigger extension width, slewing position and lifting capacities, refer to the working area charts.

TECHNICAL DESCRIPTION

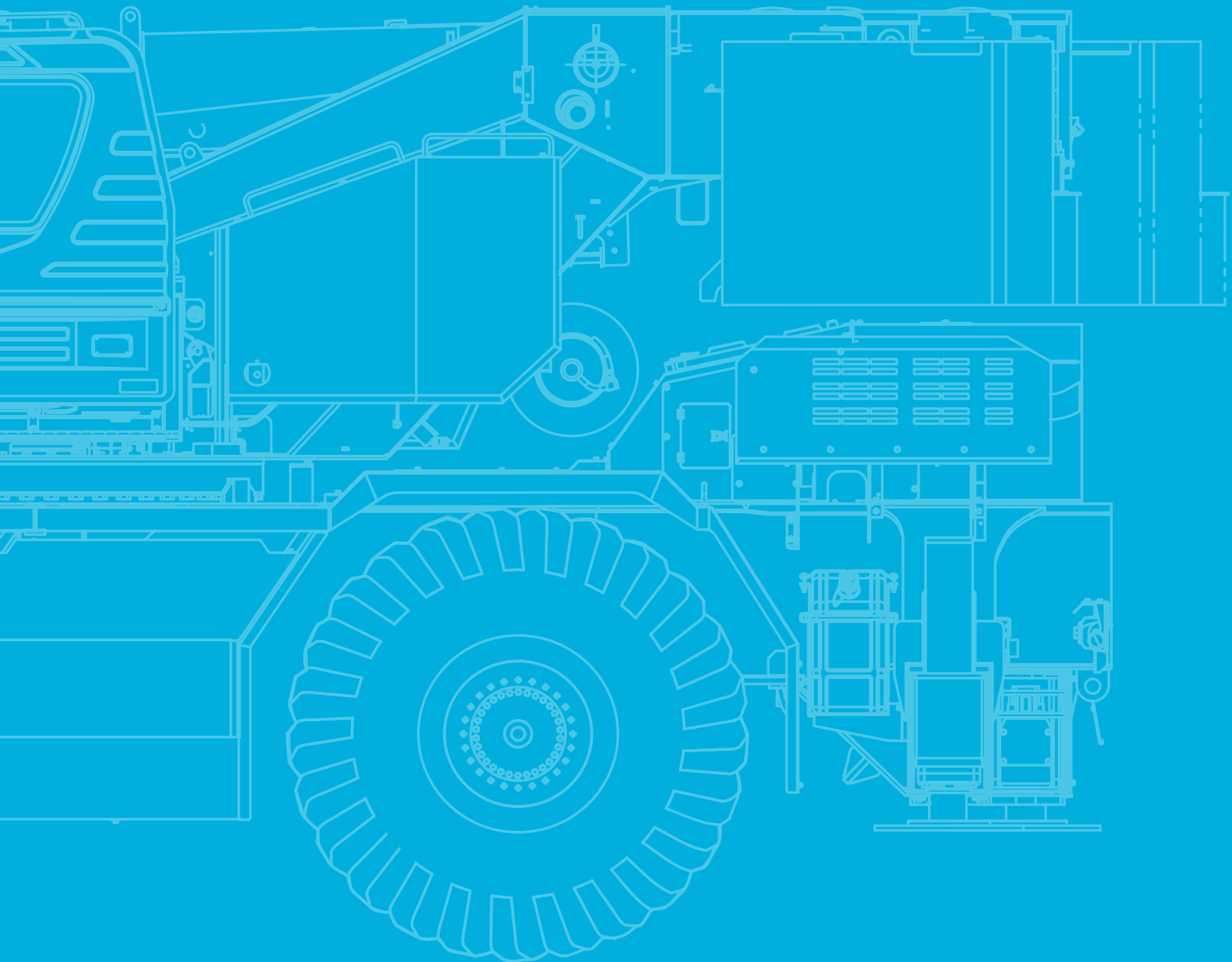

Technical Description

Crane specifications

Boom	5 section full power synchronized telescoping boom, 39.4' - 154.2' of round box construction with 7 sheaves, 17-5/16" root diameter, at boom head. The synchronization system consists of 2 telescope cylinders, an extension cable and retraction cable. Hydraulic cylinder fitted with holding valve. 2 easily removable wire rope guards, rope dead end provided on both sides of boom head. Boom telescope sections are supported by wear pads both vertically and horizontally. Extension speed 114.8' in 155 seconds.
Boom elevation	By a double acting hydraulic cylinder with holding valve. Elevation -1.5° -80.5°, combination controls for hand or foot operation. Boom angle indicator. Automatic speed reduction and slow stop function. Boom raising speed 20° to 60° in 46 seconds.
Jib	2 stage bi-fold lattice type, 3.5°, 25° or 45° offset (tilt type). Single sheave, 15-5/8" root diameter, at the head of both jib sections. Stored alongside base boom section. Jib length is 33.2' or 58.1'. Assistant cylinders for mounting and stowing, controlled at right side of superstructure. Self stowing jib mounting pins.
Auxiliary lifting sheave (single top)	Single sheave, 15-5/8" root diameter. Mounted to main boom head for single line work (stowable).
Anti-two block	Pendant type over-winding cut out device with audio-visual (FAILURE lamp /BUZZER) warning system.
Slewing	Hydraulic axial piston motor through planetary slewing speed reducer. Continuous 360° full circle slewing on ball bearing turn table at 1.5 min ⁻¹ (rpm). Equipped with manually locked /released slewing brake. A 360° positive slewing lock for pick and carry and travel modes, manually engaged in cab. Twin slewing system: Free slewing or lock slewing controlled by selector switch on front console.
Winch	<p>MAIN WINCH: Variable speed type with grooved drum driven by hydraulic axial piston motor through speed reducer. Power load lowering and raising. Equipped with automatic brake (neutral brake) and counterbalance valve. Controlled independently of auxiliary winch. Equipped with cable follower and drum rotation indicator.</p> <p>DRUM: Grooved 14-1/4" root diameter x 26-13/16" wide. Wire rope: 830' of 3/4" diameter rope. Drum capacity: 1135' 7 layers. Maximum single line pull: 1st layer 20,000 lb. Maximum permissible line pull wire strength: 14,600 lb.</p> <p>AUXILIARY WINCH: Variable speed type with grooved drum driven by hydraulic axial piston motor through speed reducer. Power load lowering and raising. Equipped with automatic brake (neutral brake) and counterbalance valve. Controlled independently of main winch. Equipped with cable follower and drum rotation indicator.</p> <p>DRUM: Grooved 14-1/4" root diameter x 26-13/16" wide. Wire rope: 456' of 3/4" diameter rope. Drum capacity: 1135' 7 layers. Maximum single line pull: 1st layer 20,000 lb. Maximum permissible line pull wire strength: 14,600 lb.</p> <p>WIRE ROPE: Non-rotating 3/4" P · S (19) + 39 x P · 7. Breaking strength 72,800 lb.</p>
Hook blocks	100 ton - 8 sheaves with swivel hook and safety latch, for 3/4" wire rope. 7.3 ton - Weighted hook with swivel and safety latch, for 3/4" wire rope.
Counterweight	Self-removable counterweight: 20,100 lb.
Hydraulic system	<p>PUMPS: 2 variable piston pumps for crane functions. Tandem gear pump for steering slewing and other hydraulic systems. Powered by carrier engine. Pump disconnect for crane is engaged/disengaged by rotary switch from operator's cab.</p> <p>CONTROL VALVES: Multiple valves actuated by pilot pressure with integral pressure relief valves.</p> <p>RESERVOIR: 210 gallons capacity. External sight level gauge.</p> <p>FILTRATION: BETA10 = 10 return filter, full flow with bypass protection, located inside of hydraulic reservoir. Accessible for easy replacement.</p> <p>OIL COOLER: Air cooled fan type.</p>
Cab and controls	Both crane and drive operations can be performed from one cab mounted on rotating superstructure. 20° tilt, left side, 1 man type, steel construction with sliding door access and safety glass windows opening at side. Door window is powered control. Windshield glass window and roof glass window are shatter-resistant. Tilt-telescoping steering wheel. Adjustable control lever stands for slewing, boom elevating, boom telescoping, auxiliary winch and main winch. Control lever stands can change neutral positions and tilt for easy access to cab. 3 way adjustable operator's seat with high back, headrest and armrest. Engine throttle knob. Foot operated controls: boom elevating boom telescoping, service brake and engine throttle. Hot water cab heater and air conditioning. Dash-mounted instrument panel, multi function display, starter switch (engine start/stop), 12 V power outlet, USB port, drive selector switch, parking brake switch, steering mode select switch, power window switch, pump engaged/disengaged switch, slewing brake switch, telescoping/auxiliary winch select switch, outrigger controls, free slewing/lock slewing selector switch, air conditioning control switch. Instruments panel: Torque converter oil temperature, engine water temperature, air pressure, fuel, speedometer, tachometer, hour meter and odometer/tripmeter. Multi function display: DEF level gauge, fuel consumption monitor.

Technical Description

Crane specifications

Tadano electronic LOAD MOMENT INDICATOR system (AML-E2) including:
Control lever lockout function with audible and visual pre-warning. Number of parts of line. Boom position indicator. Outrigger state indicator. Slewing angle. Boom angle / boom length / jib offset angle / jib length / load radius / rated lifting capacities / actual loads read out. Potential lifting height. Ratio of actual load moment to rated load moment indication. Automatic speed reduction and slow stop function on boom elevation and slewing. Working condition register switch. Load radius / boom angle / tip height / slewing range preset function. External warning lamp. Tare function. Main hydraulic oil pressure. Fuel consumption monitor. Main winch / auxiliary winch select. Drum rotation indicator (audible and visible type) main and auxiliary winch. On rubber indicator.

TADANO AML-E2 monitors outrigger extended length and automatically programs the corresponding "RATED LIFTING CAPACITIES" table.

Operator's right hand console includes transmission gear selector, slewing lock lever and sight level bubble. Upper console includes, roof washer and wiper switch, emergency outrigger set up key switch, jib equipped / removed select switch, high speed winch (main/aux.) switch, cab tilt switch, pump disconnect enable switch and boom emergency telescoping switch (2nd and 3rd-top).

NOTE: Each crane motion speed is based on unladen conditions.

Carrier specifications

Type	Rear engine, left hand steering, driving axle 2-way selected type by manual switch, 4 x 2 front drive, 4 x 4 front and rear drive.
Frame	High tensile steel, all welded mono-box construction.
Engine	Model: Cummins B6.7 · Type: Direct injection diesel · No. of cylinders: 6 · Combustion: 4 cycle, turbo charged and after cooled · Bore x stroke: 4.212 in. x 4.882 in. · Displacement: 409 cu. in liters · Air inlet heater: 24 volt preheat · Air cleaner: Dry type, replaceable element · Oil filter: Full flow with replaceable element · Fuel filter: Full flow with replaceable element · Fuel tank: 79.2 gallons, right side of carrier · Cooling: Liquid pressurized, recirculating by-pass · Radiator: Fin and tube core, thermostat controlled · Fan: Suction type, 9-blade, 28 in. diameter · Starting: 24 volt · Charging: 24 volt system, negative ground · Battery: 2-120 amp. hour · Compressor, air: 17.0 cfm @ 2,400 rpm · Output, max.: Gross 280 HP (209 kW) @ 2,200 rpm · Torque, max.: 850 ft-lb (1,152 Nm) @ 1,500 rpm · Capacity: Cooling water 2.7 gallons, lubrication 4.0 gallons, fuel 79.2 gallons, DEF/AdBlue 15.0 gallons.
Transmission	Electronically controlled full automatic transmission. Torque converter driving full powershift with driving axle selector. 6 forward and 2 reverse speeds, constant mesh. 3 speeds - high range - 2 wheel drive; 4 wheel drive. 3 speeds - low range - 4 wheel drive.
Travel speed	22 mph.
Gradeability	93% (at stall), 57% machine should be operated within the limit of engine crankcase design (30°: Cummins B6.7).
Axle	Front: Full floating type, steering and driving axle with planetary reduction. Rear: Full floating type, steering and driving axle with planetary reduction and non-spin rear differential.
Steering	Hydraulic power steering controlled by steering wheel. Four steering modes available: 2 wheel front, 2 wheel rear, 4 wheel coordinated and 4 wheel crab.
Suspension	Front: Rigid mounted to frame. Rear: Pivot mounted with hydraulic lockout device.
Brake systems	Service: Air over hydraulic disc brakes on all 4 wheels. Parking / Emergency: Spring applied-air released brake acting on input shaft of front axle. Auxiliary: Electro-pneumatic operated exhaust brake.
Tires	29.5-25 36PR (OR) - air pressure: 68 psi or 29.5-25 40PR (OR) - air pressure: 67 psi.
Outriggers	Four hydraulic, beam and jack outriggers. Vertical jack cylinders equipped with integral holding valve. Each outrigger beam and jack is controlled independently from cab. Beams extend to 23' 11-3/8" center-line and retract to within 10' 10-1/2" overall width with floats. Outrigger jack floats are attached thus eliminating the need of manually attaching and detaching them. Controls and sight bubble located in superstructure cab. Four outrigger extension lengths are provided with corresponding "RATED LIFTING CAPACITIES" for crane duty in confined areas. Min. extension: 8' 10-1/4" center to center Mid. extension: 18' 1/2" center to center Mid. extension: 21' 11-3/4" center to center Max. extension: 23' 11-3/8" center to center Float size (diameter): 1' 11- 5/8"

Technical Description

Standard equipment

5 section full power partially synchronized boom	39.4' - 154.2'
Bi-fold lattice jib	Tilt type – 33.2' or 58.1' – with 3.5°, 25° or 45° pinned offsets and self storing pins.
Quick reeving type bi-fold jib	
Anti-two block device	Overwind cutout.
Winch drum camera	With light.
LED work lights	
Variable speed main winch	With grooved drum, cable follower, drum rotation indicator (audible, visible and thumper type) and 830' of 3/4" cable.
Variable speed auxiliary winch	With grooved drum, cable follower, drum rotation indicator (audible, visible and thumper type) and 456' of 3/4" cable.
Auxiliary lifting sheave	Single top, stowable.
2-speed winch	
Hook block	100 ton - 8 sheaves with swivel hook and safety latch for 3/4" wire rope.
Hook	7.3 ton - with swivel.
Tadano twin slewing system and 360° positive slewing lock	
Positive control	
Hydraulic oil cooler	
3 way adjustable cloth seat	With armrests, high back and seat belt.
Tilt-telescoping steering wheel	
Tinted safety glass and sun visor	
Front windshield wiper and washer	
Roof window wiper and washer	
Power window	Cab door.
12 V power outlet	
Ashtray	
Cab floor mat	
Pump disconnect in operator's cab	
Air conditioner	Hot water heater and cooler.
Full instrumentation package	
Self centering finger control levers	With pilot control.
Control pedals	For boom elevating and boom telescoping.
Warning device (visual)	Low oil pressure / high water temperature.
Air cleaner dust indicator	
Cup holder	
Battery disconnect	
USB port	
20° tilt cab	
Emergency steering system	
Tadano electronic load moment indicator system (AML-E2)	
Boom angle indicator	

Technical Description

Standard equipment

Outrigger extension length detector

Electronic crane monitoring system

Rear view camera

Right front view camera

Fenders

Air dryer

Complete highway light package

Towing hooks Front and rear.

Hook block tie down Front bumper.

Weighted hook storage compartment

Halogen head lamp

Independently controlled outriggers

Four outrigger extension positions

Self-storing outrigger pads

Electronic controlled automatic transmission driven by torque converter

Drive / steer 4 x 4 x 4.

Non-spin rear differential

Automatic rear axle oscillation lockout system

Tires 29.5-25 36 PR tires. 29.5-25 40 PR tires.

Disc brakes

Water separator with filter High filtration.

Back-up alarm

24 volt electric system

Tool storage compartment

Tire inflation kit

Engine Cummins B6.7 turbo charged after cooled engine (280 HP) with exhaust brake.

Engine over-run alarm

Lifting eyes

Telematics Machine data logging and monitoring system with HELLO-NET via internet (availability depends on countries).

Fuel consumption monitor

Eco mode system

Self-removable counterweight

Radiator cover

Clearance sonar Rear side.

Automatic pump disconnect

Over unwinding prevention

Optional equipment

Auxiliary power unit

tac.sales@tadano.com
www.tadanoamericas.com

Tadano PanAmerican Operations
4242 W Greens Road, Houston, TX 77066
Phone: +1 (281) 869-0030



Lifting your dreams

